



JOHN DEERE 3000 SERIES (4200/4300/4400) (4210/4310/4410) (3120/3320/3520/3720)
JOHN DEERE 4000 SERIES (4500/4600/4700) (4510/4610/4710) (4120/4320/4520/4720)
OPTIONAL AUXILIARY HEATER INSTALLATION (p/n 9PH20S26)

HEATER PLUMBING:

***** CAUTION *** To avoid injury caused by hot engine coolant, make sure the engine is completely cooled down before beginning installation of auxiliary heater.**

- A. Remove engine covers. Drain coolant.
- B. Remove plastic plugs from right front leg of cab and install plastic bushings from the electrical kit.
- C. **For the following 16 models (4210/3120/3320/3520/3720/4200/4300/4400/4500/4600/4700/4310/4410/4510/4610/4710)**, use the general installation photos on page 2. Remove the large hex head plug from underneath the thermostat and install one nylon washer and the sending unit adaptor. Reinstall the hex head plug unit to the end of the adaptor. Install the nipple to the side of the sending unit adaptor. **(SEE FIG. 1)**. If the sending unit adapter does not tighten so that the port on the side for the 3/8" NPT nipple orients as desired, then remove it and install another nylon washer and try again. **Skip to step F.**
- D. **For the following four models (4120/4320/4520/4720)**, use the specific installation photos on page 3. Remove the two solid plugs shown in figures 6 and 7. Install two male nipples as shown in figures 7 and 8. Cut heater hose in half. Attach the heater hoses to these nipples using the supplied hose clamps shown in fig. 7. Route these hoses through the opening shown in fig. 9. On the left side of the vehicle, cable tie the heater hoses to the hole in the muffler support as shown in figures 9 and 10. Thread the hoses behind the water separator hose, behind the alternator, and underneath the single wire as shown in fig. 11. Route hoses through the bushings in the right, front leg, from Step B, as shown in fig. 12. **Go to step G.**
- E. **For the following 15 models (3120/3320/3520/3720) (4200/4300/4400) (4500/4600/4700) (4310/4410) (4510/ 4610/4710)**, remove the allen head plug from underneath the thermostat and install the nipple (See fig. 2).
- F. **(SEE FIGURES 3 & 4)** For the supply line to the heater, cut a 6 foot length from the supplied heater hose. Place a small hose clamp over the end of the heater hose, press it onto the nipple and tighten the hose clamp. Feed the heater hose from the engine compartment to the right front leg of the cab and feed it through one of the bushings installed in step B. For the return line to the heater, splice into the lower radiator hose with the T fitting and large hose clamps provided. Install remaining heater hose onto T with a small hose clamp and route to the right front leg and feed through remaining bushing from step B .
- G. **(SEE FIGURES 3)**The suggested location for the in-line shut off valve is in the engine compartment. Splice into the heater supply line and install the in-line shut-off valve with small hose clamps. **NOTE:** The in-line shut-off valve quickly converts the heater into a summer time blower by preventing hot water from flowing to the heater core.
- H. Temporarily install the 20,000 BTU MEGA BURNER heater to the bracket on the right unitized side frame using the 1/4" bolts located on the side of the heater. Check hose routing and secure with large wire ties making sure that they do not rub against any moving parts, do not interfere with right side engine cover, kink when cover is installed, or rub against right front tire when turned. Trim hoses to length at heater, remove plugs from heater core (if equipped) and install hoses to the heater with the remaining hose clamps. Place heater on tractor floor **(SEE FIGURE 3, 4 & 5)**.
- I. Refill the cooling system. The system will not operate correctly with air present in the lines. Start tractor and check system for leaks. Let the tractor run and confirm that both heater hoses get warm. If they do not, let the system cool and try the following:
 - Back fill the heater and hoses with coolant.
 - Only while bleeding the lines, restrict flow to the radiator by clamping the upper hose to force water to flow through the heater. **REMOVE CLAMP** when bleeding the lines is complete.
 - Add coolant to the reservoir through several heating and cooling cycles to bleed air from the lines.



Installation photos for the following 16 models: (4210)
(3120/3320/3520/3720) (4200/4300/4400) (4500/4600/4700)
(4310/4410) (4510/4610/4710)

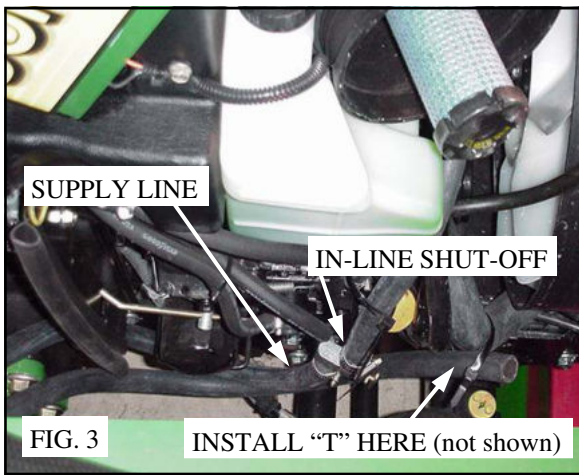
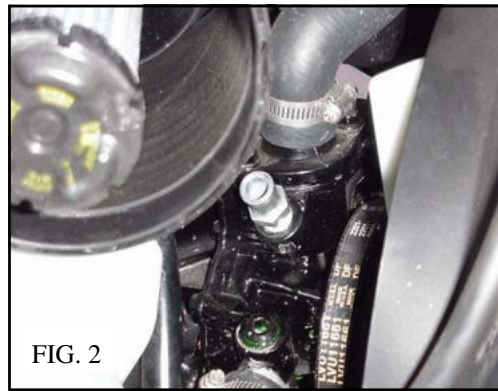
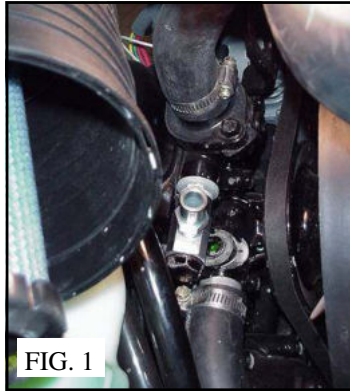



Installation photos for the following 4 models: (4120/4320/4520/4720)

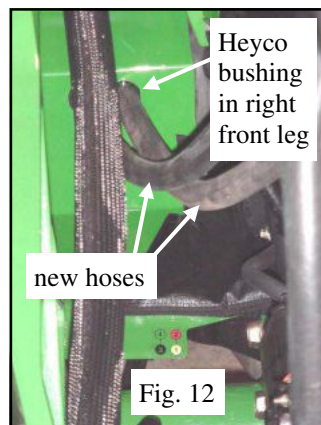
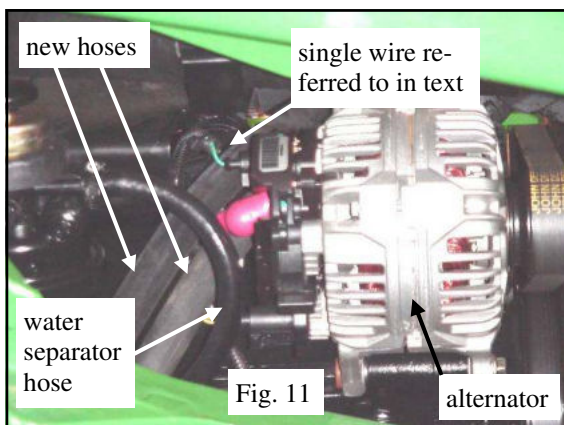
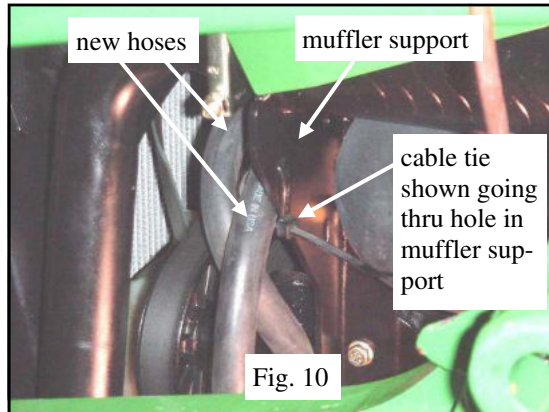
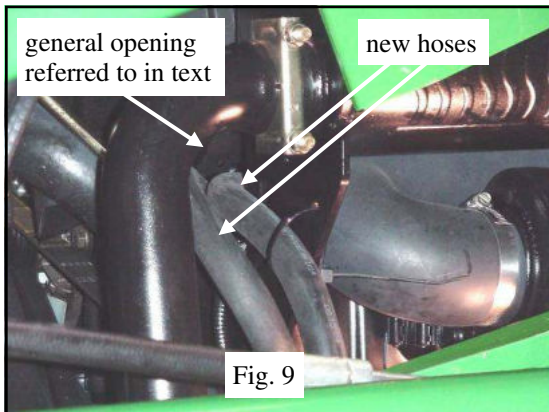
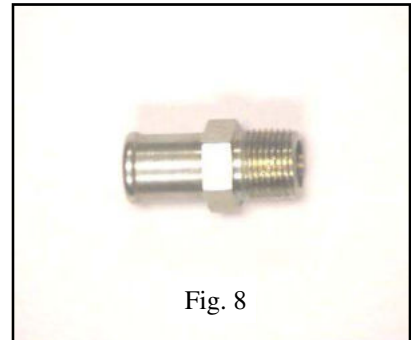
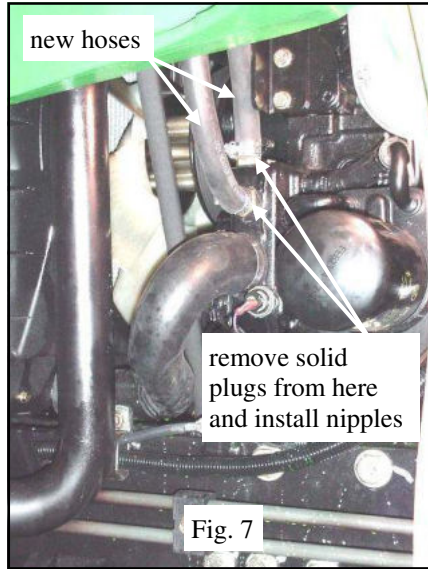
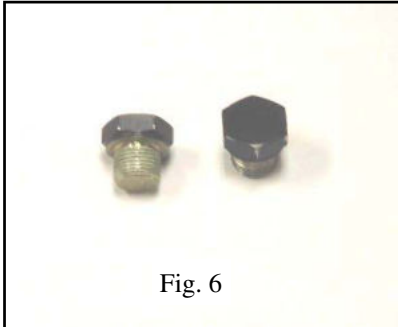



ELECTRICAL CONNECTIONS: (see fig. 13)

- A. At the installer’s discretion, mount the two speed rotary heater switch in desired location.
- B. Install the supplied 18 gauge wires to the heater with the female bullet connectors on the end of the wires. Route the wires to the switch location and cut to desired length. Connect to “H”-high, and “L”-low, male plugs on the back of the rotary switch with female push-on connectors. NOTE: connect the wire from the ORANGE motor wire to the switch “H”-high terminal, and the wire from the RED motor wire to the switch “L”-low terminal. Connect the black wire from the motor to ground.
- C. Install the fuse in the in-line fuse holder and cut the wire loop. Install a butt connector to one end of the fuse holder. Connect a piece of the remaining 18 gauge wire to the butt connector. Connect the other end of the in-line fuse holder to a positive feed (through the ignition or fuse box is recommended). Route the wire to the back of the switch and connect to the “B” terminal with a female push-on connector. ****WARNING** Leave the “C” switch OPEN. This is NOT a ground connection.**

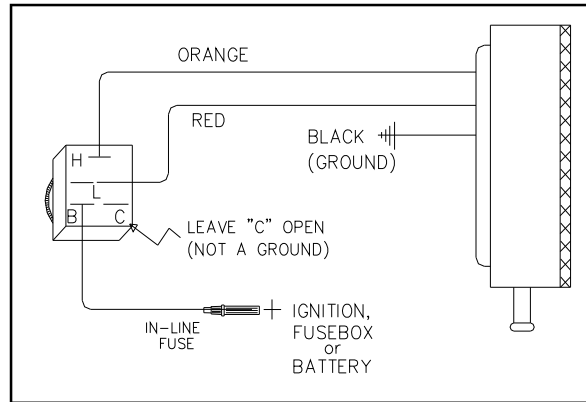

FIG. 13

HEATER COMPONENTS

QTY.	DESCRIPTION	P/N	QTY.	DESCRIPTION	P/N
1)	20,000 BTU MEGA BURNER HEATER	9PH20	1)	SENDING UNIT ADAPTOR	9PH20S30P7
1)	HEATER MANUAL	N/A	1)	HEATER WIRE KIT	N/A
1)	17' HEATER HOSE	9HR0061	2)	18 MM x 1.5 NIPPLES (used on 20 series)	9HR0045-A
1)	3/8" NPT NIPPLE	9HR0045	1)	ROTARY HEATER SWITCH	9HR0046
6)	1" HOSE CLAMPS	9HR0060-1.0	3)	16 MM NYLON WASHERS	N/A
2)	1-1/2" HOSE CLAMPS	9HR0060-1.5	2)	LARGE WIRE TIES	N/A
1)	IN-LINE SHUT-OFF VALVE	9HR0044			
1)	1" x 5/8" x 1" T-FITTING	9HR0042			



20,000 BTU MEGA BURNER HEATER SERVICE PARTS

<u>ITEM NO.</u>	<u>DESCRIPTION</u>	<u>CODE NO.</u>
1	HEATER CORE - 20,000 BTU	9PH20-1
2	FAN/MOTOR - 20,000 BTU	9PH20-2
3	VENT/LOUVER RECTANGLE	9HR-L

