



New Holland Workmaster 25S Cab with Heater (p/n: 1NHWM25SCA) fits tractor models: Workmaster 25S

While this cab kit was designed to fit on the vehicle(s) listed above, manufacturing tolerances and vehicle assembly may affect cab fitment. It is the responsibility of the cab installer to check all vehicle pedals and levers for full functionality and, as required, adjust the cab fitment to prevent any interference of the cab components with the travel of pedals or levers.



Available Options:

1. Front LED Work Lights (P/N: 9LEDW4)
2. Rear LED Work Lights (P/N: 9LEDW3)
3. Strobe Light (P/N: 9LEDS2)
4. Dome Light (P/N: 9LEDD14)
5. Side View Mirrors (P/N: 9PM5)
6. Rear View Mirror (P/N: 9PM3)
7. Rear Wiper (P/N: 9PWK8512F9-11A)
8. Seal Kit (P/N: 9SK8)
9. Adaptor Kit to Mount Cab Without Loader (P/N: 1NHWM25SAK)

Approximate Installation Time *
Experienced Dealer Technician – 6 Hours
Average Dealer Technician – 8 Hours
Do-It-Yourself – 10 Hours

(*=Not including accessories)

Approximate Product Specifications
Floorboard to Roof Height: 61.625 inches
Weight: 329 lbs.
Cab Width: 47.625 inches (w/o side mirrors)

The contents of this envelope are the property of the owner. Leave with the owner when installation is complete.

NEW HOLLAND WORKMASTER 25S CAB SERVICE PARTS

ROOF ASSEMBLY
P/N: 8SV-101-00057

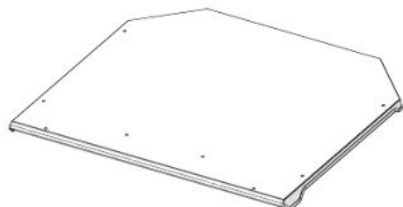

WINDSHIELD ASSEMBLY
P/N: 8SV-102-00031



WINDSHIELD SUPPORT
P/N: 8SV-103-00025



COWL ASSEMBLY
P/N: 8SV-105-00027

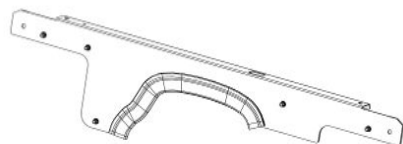

RADIATOR SHROUD ASSEMBLY
P/N: 8SV-111-00032

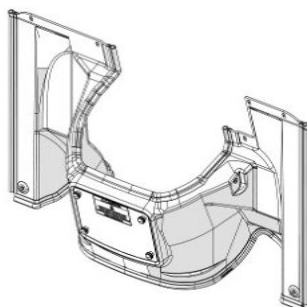

DOOR ASSEMBLY, LEFT
P/N: 8SV-107-00041-L



DOOR ASSEMBLY, RIGHT
P/N: 8SV-107-00041-R



REAR LEG ASSEMBLY, LEFT
P/N: 8SV-108-00023-L



REAR LEG ASSEMBLY, RIGHT
P/N: 8SV-108-00023-R



SIDE FRAME ASSEMBLY, LEFT
P/N: 8SV-109-00021-L



SIDE FRAME ASSEMBLY, RIGHT
P/N: 8SV-109-00021-R



DOOR WINDOW WITH RUBBER
P/N: 8SV-9GL-00058



NEW HOLLAND WORKMASTER 25S CAB SERVICE PARTS

ROPS CLAMP ASSEMBLY
P/N: 8SV-110-00062

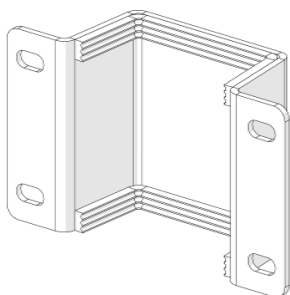

BRACKET, ROPS, ASSEMBLY, LEFT
P/N: 8SV-110-00082-L

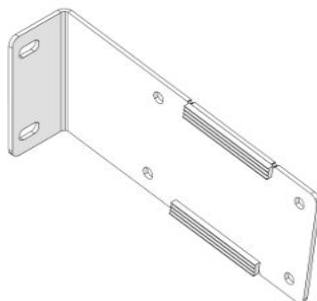

BRACKET, ROPS, ASSEMBLY, RIGHT
P/N: 8SV-110-00082-R

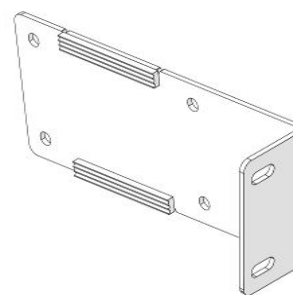

BRACKET, LOWER, REAR MOUNT
P/N: 8SV-SM-01752

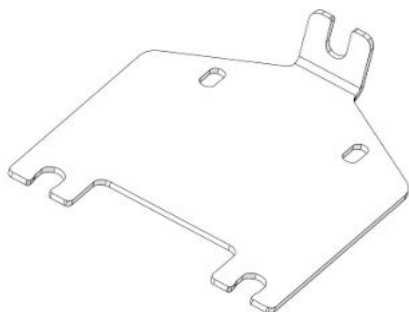

SET OF LOWER REAR MOUNTS; P/N: 8SV-SM-01753

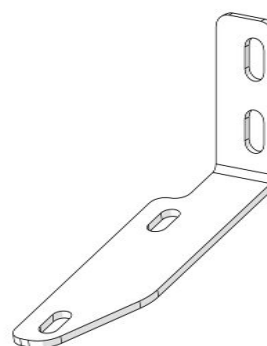
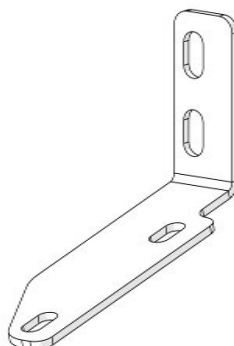

LOADER LOCK LEVER EXT BRACKET W/
INSERT; P/N: 8SV-113-00226

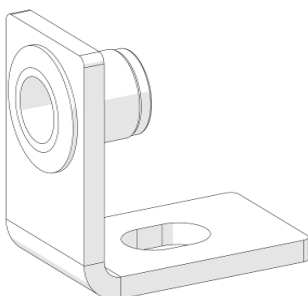

TOOL BOX OFFSET BRACKET
P/N: 8SV-SM-01776

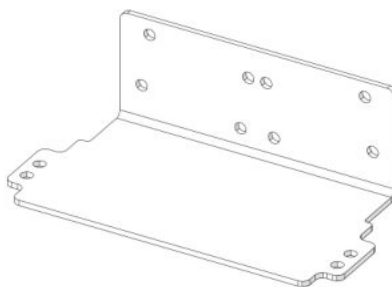

HEATER BRACKET
P/N: 8SV-SM-01756

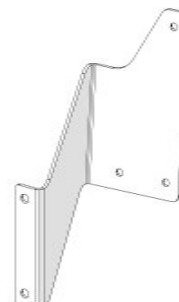

GLASS REAR PANEL LIFT OFF
P/N: 8SV-106-00021



LOWER REAR PANEL ASSEMBLY
P/N: 8SV-106-00038

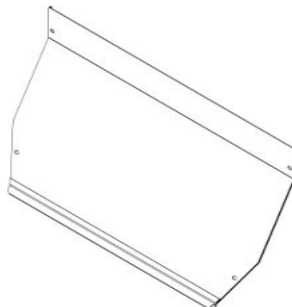

GLASS HINGE SLEEVE WITH MOUNTING
HARDWARE
P/N: 8SV-PL-00021

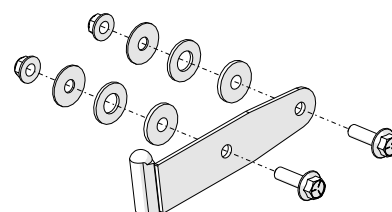

NEW HOLLAND WORKMASTER 25S CAB SERVICE PARTS

SET OF LOWER FRONT MOUNTS
P/N: 8SV-SM-01771

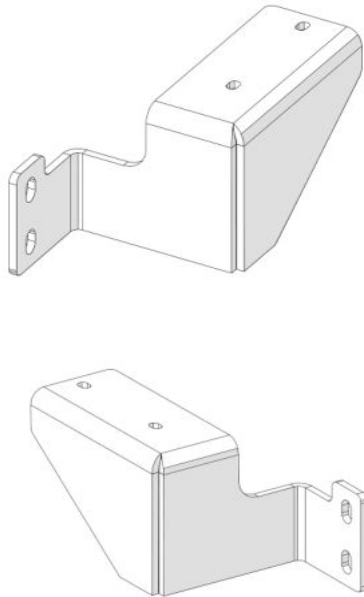

HINGE KIT, TOP & BOT, LEFT
P/N: 8SV-HKWTB-L

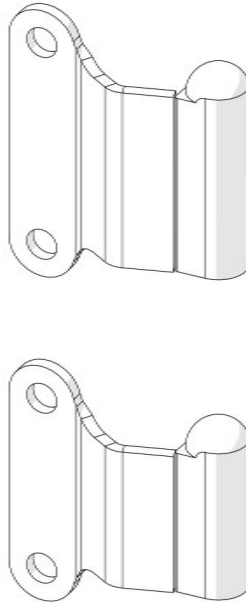

HINGE KIT, TOP & BOT, RIGHT
P/N: 8SV-HKWTB-R

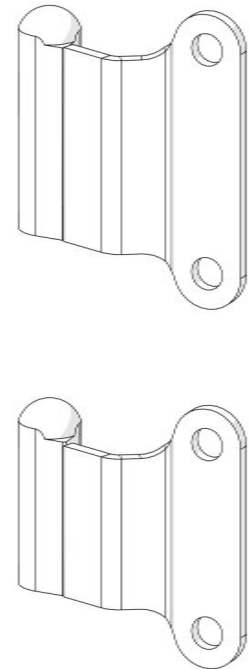

IN-LINE COUPLING, MALE INSERT
P/N: 9HR0066

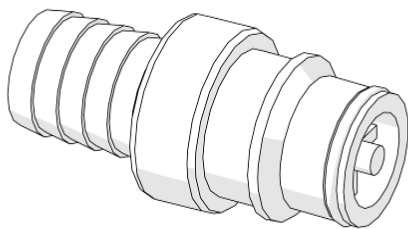

IN-LINE COUPLING, FEMALE BODY
P/N: 9HR0067

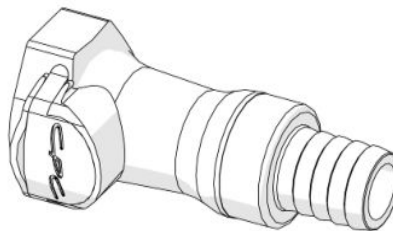

EXTENDED SENDING UNIT ADAPTER
P/N: 9HR0051MF1

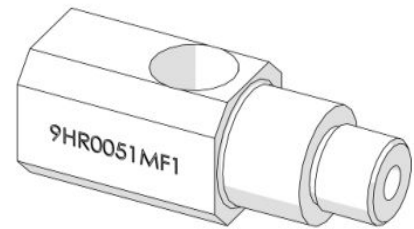



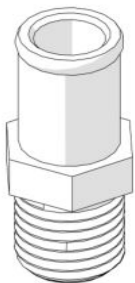





BLOCK ADAPTER (3/8" NIPPLE)
P/N: 9HR0045

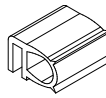
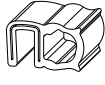
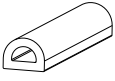

ADDITIONAL SERVICE PARTS

PART NUMBER	DESCRIPTION
9SV-DL173	DECAL, HEARING PROTECTION
8SV-LCH-00007	LATCH SET WITH MOUNT, POP OUT, SINGLE ARM, 3" OPENING (LEFT AND RIGHT PAIR)
9SV-9PWM110	WIPER MOTOR, 110 DEGREE
9PWB20-FB	WIPER BLADE, 20", FLEX
9SV-9PWA14-16	WIPER ARM, ADJUSTABLE LENGTH (11" - 16")
9SV-PWKHB	GLASS MOUNTING KIT FOR WIPER SYSTEMS
9SV-GS02Q	GAS SPRINGS, 12-3/8 EXT, QUICK DISCONNECT ENDS (SET OF 2)
9SV-DSTRH	DOOR STRIKER KIT - INCLUDES CASE HARDENED STRIKER BOLT
9SV-IHRL	INSIDE HANDLE ROTARY LATCH KIT (INCL. L & R)
9SV-OHRL	OUTSIDE HANDLE ROTARY LATCH KIT (SET OF 2)
9SV-9PHW010-W	HINGE WASHER, KIT (SET OF 4) OD .635, ID .41, THK .08
9SV-GS02A	BALL STUDS, 10MM (BAG OF 10)
9PI01	POLY INSERT 1", 14-20 GA BLK MATTE, INSERT FINS .94/.95 (QTY.: 1)
9PI02	POLY INSERT 3/4", 14-20 GA BLK MATTE FINISH, INSERT FINS 0.69 (QTY.: 1)
9SV-9HR00601.0	HOSE CLAMPS #10 (1") (QTY.: 6)
9SV-9HR0048	ROCKER SWITCH (HI-OFF-LOW)
9SV-9HR-L	REPLACEMENT LOUVER-15,000 & 20,000 BTU HEATER
8SV-9PH20WG	TUCK-AWAY HEATER WITH WIRED GROUND
9SV-HRH61-20	HEATER HOSE (5/8" I.D.)-20 FT
9SV-TBP12920	HARNESS (SPIRAL) WRAP, CUT 20"
9SV-WH-00072	WIRING HARNESS POWER
8SV-WH-GF	WIRE HARNESS, GLASS FUSE
9DL01H	KEYS, SET OF 2 ON A RING, FOR HANDLE 1096-1, KEY CODE C40

TRIM LOK, STD, 1/16" - 1/8" GRIP  9SV-PRO1-20	5/8" STD BULB, 1/16" GRIP  9SV-PRO2-15	1" FLAT BULB, 1/16" GRIP  9SV-PRO5-10	1/2" WEATHERSEAL  9SV-PR20-10	WINDOW RUBBER  9SV-PR10-10	1" ROUND BULB, 1/16" GRIP  9SV-PR19-10	3/4" SIDE BULB, 1/16" GRIP  9SV-PR17-20	3/4" SIDE BULB, 1/4" GRIP  9SV-PR38-15	ARCH PSA .2 X .15  9SV-PR53-15	
					5/8" STD BULB, 1/4" GRIP  9SV-PRO7-5				