



**KUBOTA L3301 and L3901
Premium Cab (p/n: 1KL39PR)
Standard Cab (p/n: 1KL39ST)**

While this cab kit was designed to fit on the vehicle(s) listed above, manufacturing tolerances and vehicle assembly may affect cab fitment. It is the responsibility of the cab installer to check all vehicle pedals and levers for full functionality and, as required, adjust the cab fitment to prevent any interference of the cab components with the travel of pedals or levers.

The contents of this envelope are the property of the owner.
Be sure to leave with the owner when installation is complete.

APPROXIMATE INSTALLATION TIME: 2 to 3 HOURS
(excluding accessories)



Standard cab with optional front windshield wiper (p/n: 9PWK110) shown here.
Note: a front windshield wiper is included with the premium cab kit.

Available Options:
Front LED Work Lights (P/N: 9LEDW4)
Rear Wiper: 9PWK85
Heater: 9PH20S60

Rev. E, 02/02/2023

p/n: IM-1KL39PR

**NOTICE**

Curtis Cabs, blades and general accessories add additional weight to the base vehicle. All Curtis accessory weights are listed in product brochures. Deduct the accessory's total weight from the vehicle's rated capacity and never exceed the vehicle's rated capacity including driver and passenger.

**WARNING** Exposure to Carbon Monoxide can Cause illness, serious injury or death.

Never operate vehicle if suspicious of Carbon Monoxide. Inspect exhaust system for leaks monthly. Leaks can result from loose connections, corrosion, cracks or other damage to the exhaust manifold. If leaks are found, repair or replace exhaust system. Do not use vehicle until repair or replacement is complete.

**WARNING****Serious Injury or Death**

This cab enclosure does not provide protection from rollover or other accidents.



This cab enclosure does not provide protection from flying objects including golf balls.



This cab enclosure does not provide protection from lightning. When lightning threatens take cover and do not operate vehicle.

CAB INSTALLATION BEFORE YOU START

HELPFUL HINTS:

- A. Refer to parts diagram toward the back of this manual to help identify parts during the assembly process.
- B. To assist with the cab installation, leave all bolts loose for later adjustment unless otherwise specified.
- C. Read and understand all instructions before beginning.
- D. Plastic washers have been supplied to provide a weather seal under the heads of all exterior bolts. The plastic washer should be installed under each bolt head directly against the outside cab surface. Care should be taken not to over tighten the fasteners and damage the plastic washer. Also use steel washers as required. Tip: the black plastic washers can be difficult to distinguish from the black steel washers. Use a magnet or look for round witness marks left on the plastic washers from the mold ejector pins.
- E. Apply a clear silicone sealant to seal any minor gaps that may occur due to vehicle variations.
- F. Use caution to avoid damaging the factory installed threaded inserts. Begin the bolt engagement by hand to guard against potential cross threading.

TOOLS REQUIRED:

Set of standard and metric sockets
Set of standard and metric open end wrenches
Scissors
Shears
Tape Measure
Bar Clamp

One Phillips Head Screwdriver
One 3/8" Drive Ratchet
One 1/2" Socket (3/8" drive)
One Swivel Extension (3/8" drive)
Set of standard Allen Wrenches

1. VEHICLE PREP.

1.1 Per figures 1.1 and 1.1a, remove the grab handle from the left side of the tractor as shown. The grab handle does not get re-installed with the cab in place. Save for re-use should the cab ever be removed.

1.2 Per fig. 1.2, remove the toolbox from the ROPS (roll-over protective structure). The tool box does not get re-installed with the cab in place. Save for re-use should the cab ever be removed.

1.3 Unplug and unbolt the hazard lights (one from each side of the tractor). Save for re-installation in step 16 on page 12.

1.4 If installing a hard rear panel, position it on top of the fenders oriented so the upper bent flange is pointing towards the front of the tractor. Otherwise skip to the next step.

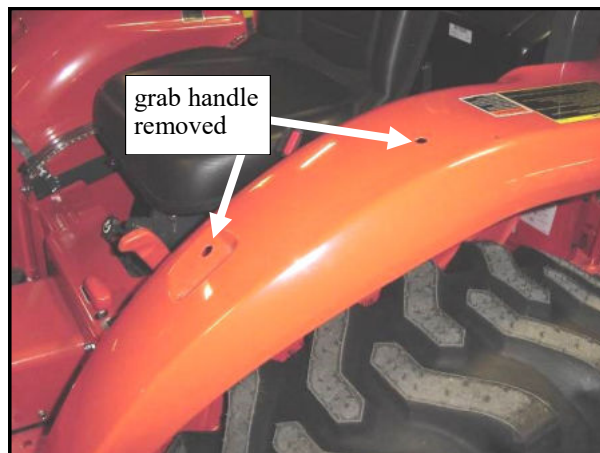

Fig. 1.1 (view from left side of tractor)

2. SIDE FRAMES

2.1 Temporarily remove the doors from the side frames for ease of handling. Open the door and lift up and off the pin hinges on the side frames.

2.2 With assistance, install right side frame per figure 2.2. Use the following hardware to attach the right side frame to the floor of the tractor: two 5/16" x 3/4" long hex flange bolts and two flange locknuts. The heads of the bolts are to be up top as shown in fig. 2.2a (flange locknuts underneath the tractor). Tighten the bolts one turn shy of fully tight. Note: the use of a swivel extension and a standard length socket (not long) would be helpful for the tight quarters under the tractor floor. Repeat for left side frame but use a 1/4" x 3/4" long hex flange bolt, 1" fender washer (on top of the floorboard), and 1/4-20 hex locknut in the front floorboard mounting hole .



Fig. 1.1a (grab handle)

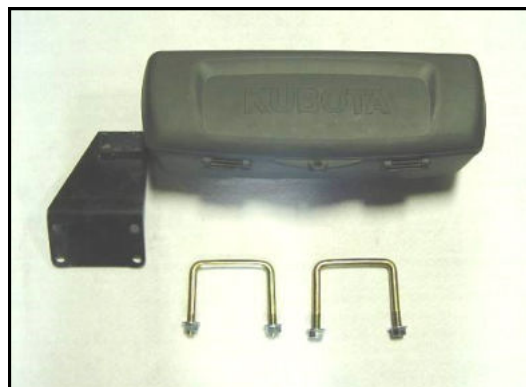

Fig. 1.2 (toolbox)

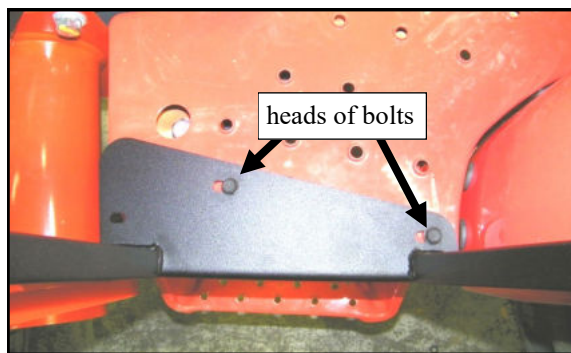

Fig. 2.2a (bird's-eye view of left side of tractor)

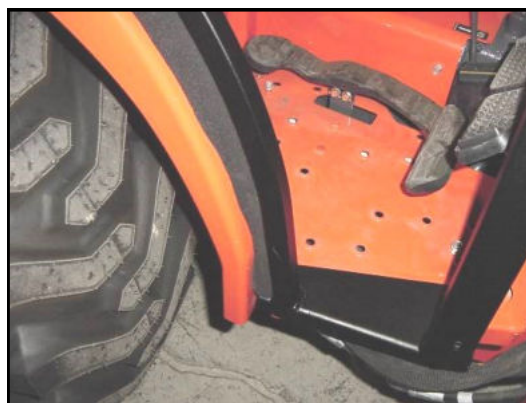

Fig. 2.2 (view from right side of tractor)

3. WINDSHIELD SUPPORT

3.1 Per fig. 3.1 and with assistance, install the windshield support oriented so the decals are legible from the driver's seat. Use the following hardware to attach the support to each side frame: a 5/16 x 3/4" long hex flange bolt, plastic washer and flange locknuts. Tip: the black plastic washers can be difficult to distinguish from the black steel washers. Use a magnet or look for round witness marks left on the plastic washers from the mold ejector pins. The heads of the bolts are to be outboard as shown (locknuts inside the cab). Do not tighten the bolts. Repeat for left side frame attachment.

4. REAR CROSS BRACE

For standard cabs. Skip this step and proceed to step 5 below if installing a premium cab with a hard rear panel.

4.1 Per fig. 4.1 and with assistance, install the rear cross brace oriented so snaps are inside the cab and the locknuts holding the snaps are outboard as shown. Use the following hardware to attach the brace to the top rear of each side frame: a 5/16 x 3/4" long hex flange bolt, plastic washer and locknut. The heads of the bolts are to be outside (locknuts inside the cab). Do not tighten the bolts. Repeat for right side frame attachment.

5. HARD REAR PANEL

For premium cabs. Skip this step and proceed to step 6 if installing a standard cab with a soft rear curtain.

5.1 Use the following hardware to attach the hard rear panel to the back side of the side frames at location "A" (2 places per side of tractor): four 5/16 x 3/4" long hex flange bolts, four plastic washers and four flange locknuts. Do not tighten the bolts. Repeat for right side frame attachment.

5.2 Install an additional four (2 per side) 5/16 x 3/4" long hex flange bolts, plastic washers, and flange locknuts in the top and bottom holes of the rear panel to further attach to the left and right side frames.

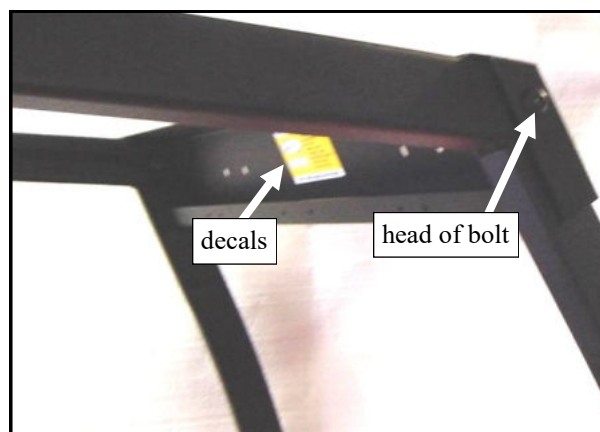

Fig. 3.1 (view from right side of tractor)

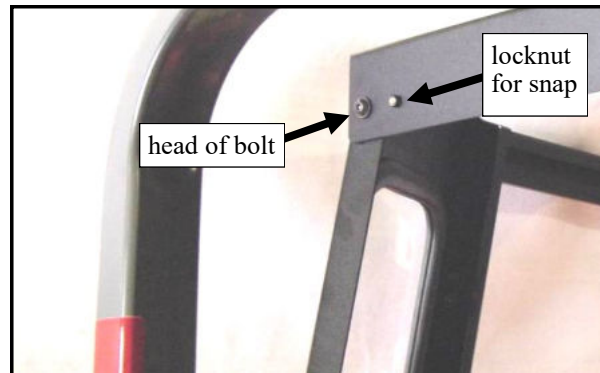

Fig. 4.1 (view from right side of tractor)

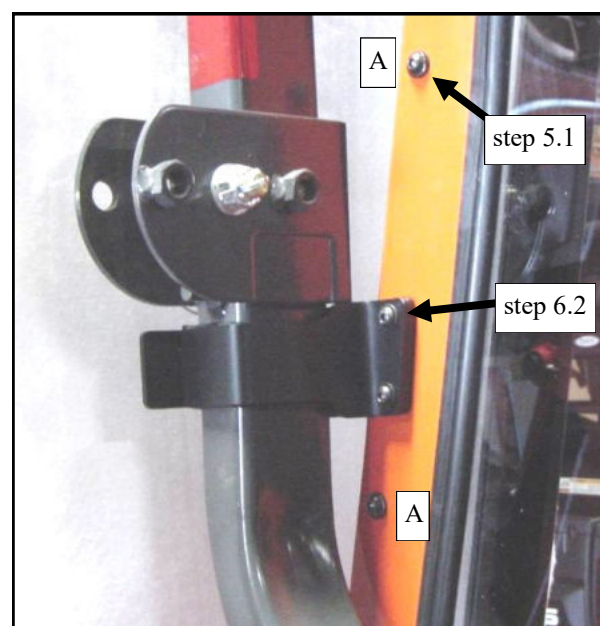

Fig. 5.1 (view of left side of tractor)
(lower roll bar mount shown here)

6. UPPER AND LOWER ROLL BAR BRACKETS & MOUNTS

6.1 See page 16 for left versus right hand parts. If installing a standard cab, have an assistant lift up on the back of the side frames (see fig. 6.1) and pull the front back when installing the roll bar brackets. This will keep the cab from sagging towards the back and rotating forward which can create an interference with the loader mounting brackets. Per figure 6.1a, install the lower roll bar brackets using the following hardware per side of the tractor: two 5/16 x 1-1/4" long button head bolts, two steel washers and two flange locknuts. The bolt heads should be towards the front of the vehicle (especially for soft rear curtain applications). Note: the photo shows a hard rear panel in place. A standard cab bolts up the same way but with one less thickness of sheet metal to sandwich. Do not tighten the bolts.

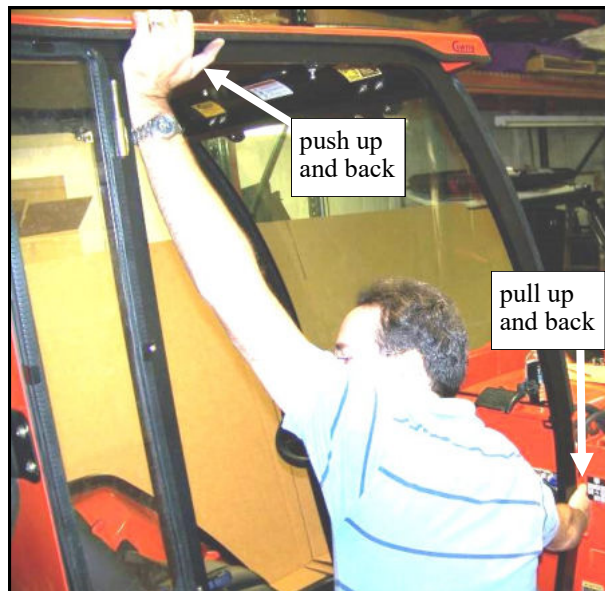

Fig. 6.1 (view of right side of tractor)

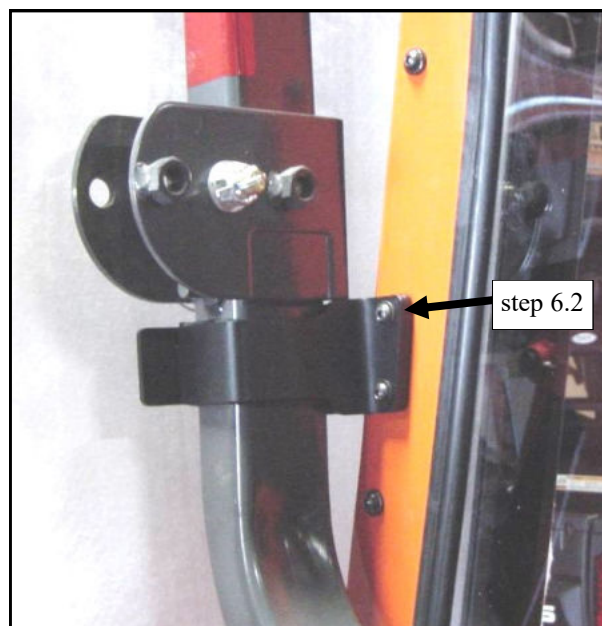

Fig. 6.1a (view of left side of tractor)
(lower roll bar mount shown here)

6. ROLL BAR BRACKETS (cont'd.)

6.2 See page 17 for left versus right hand parts. Per fig. 6.2, install the upper roll bar brackets using the following hardware per side of the tractor: four 5/16 x 1-1/4" long button head bolts, four steel washers and four flange locknuts. The bolt heads should be towards the front of the vehicle (especially for soft rear curtain applications). Note: the photo shows a soft rear curtain in place. A premium cab bolts up the same way. Do not tighten the bolts.



Fig. 6.2 (view of left side of tractor)
(upper roll bar mount shown here)

7. WINDSHIELD COWL

7.1 Per fig. 7.1, pre-assemble the cowl and the left front leg oriented so the 90 degree bent flanges on the left side of the photo are both up. The white line on the sheet metal in the photo represents the edge of the front leg (piece "f"). In this view, the front leg is to be on top of the cowl (piece "c"). Use the following hardware: two 5/16 x 3/4" long hex flange bolts, two plastic washers and two flange locknuts. Locknuts to be inboard (up in this view). Tighten bolts.

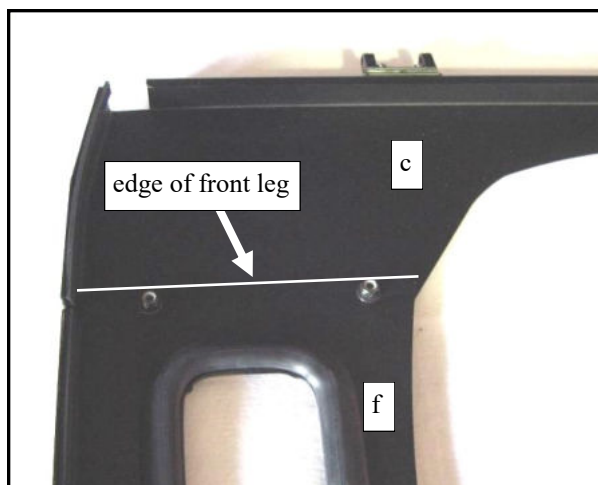

Fig. 7.1 (cowl/front left leg assembly)

7.2 Per fig. 7.2, install the supplied flat bulb rubber seal starting at point "a" and continuing onto the left front leg and ending at point "b" in fig. 7.2c (ref.: 38 inch long piece of bulb rubber).

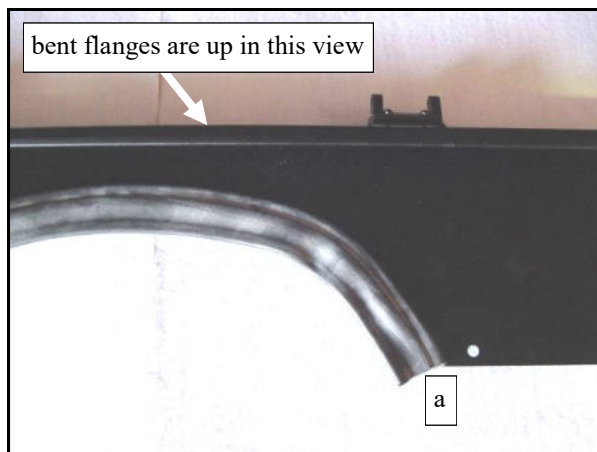

Fig. 7.2 (starting point for bulb rubber)

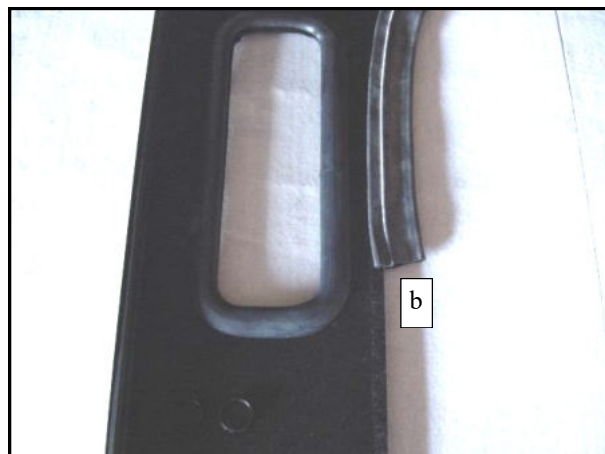

Fig. 7.2c (ending point for bulb rubber)

7. WINDSHIELD COWL (cont'd.)

7.3 Per fig. 7.3, install the two-piece, rubber-edged assembly over the hood of the tractor oriented so the upper and lower bent flanges are inside the cab (pointing towards the rear of the tractor). Fasten the left front leg and the windshield cowl to the side of the left side frame using the following hardware: five $5/16 \times 3/4$ " long hex flange bolts and five plastic washers. Use caution to avoid cross threading the factory installed threaded inserts. Begin the thread engagement by hand. Do not tighten bolts.

7.4 Per fig. 7.3, attach the bottom bent flange to the bottom of left side frame using the following hardware: a $5/16 \times 3/4$ " long hex flange bolt, plastic washer and flange locknut. Locknut to be underneath the floorboard. Do not tighten bolt.

7.5 Per fig. 7.5, attach the right side of the windshield cowl using care to not damage the factory installed weatherseal inside the bent flanges where indicated on the photo. Use the following hardware: two $5/16 \times 3/4$ " long hex flange bolts and two plastic washers.

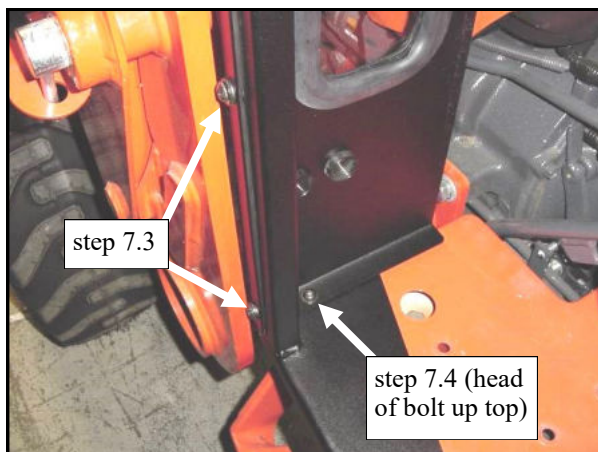

Fig. 7.3 (view from left rear side of tractor)



Fig. 7.5 (view from right side of tractor)

8. RIGHT FRONT LEG

8.1 Per fig. 8.1, install the right front leg to the side of the right side frame using care to not damage the factory installed weatherseal inside the bent flanges where indicated on the photo. Use the following hardware: two 5/16 x 3/4" long hex flange bolts and two plastic washers. Do not tighten bolts.

8.2 Per fig. 8.2, use the following hardware to connect to the bottom of the side frame: a 5/16 x 3/4" long hex flange bolt, plastic washer and flange locknut. Bolt head to be up top and locknut underneath the floor. Do not tighten bolt.

9. WINDSHIELD

9.1 See fig. 9.1. Have the following items ready: four 5-16 x 1-1/2" long flat head bolts, four flange locknuts, and two 5/8" thick plastic spacer blocks. With assistance, install the windshield hinges to the windshield support with the two spacer blocks between the hinge and the windshield support. Attach the windshield latches to the windshield latch receivers on the cowl by squeezing the spring-loaded pin ends and fitting them in place into the receiving holes.

9.2 See fig. 9.2. Lift up on the bottom of the windshield and close the latches. Check the alignment of the windshield with the side frames and tighten the hinge hardware. **CAUTION: hinges are plastic components with countersunk holes. Do not overtighten hardware. Torque to 7 foot-pounds max..**

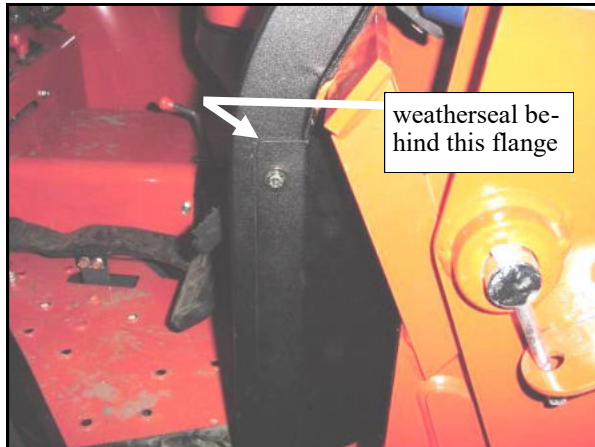

Fig. 8.1 (view from right side of tractor)

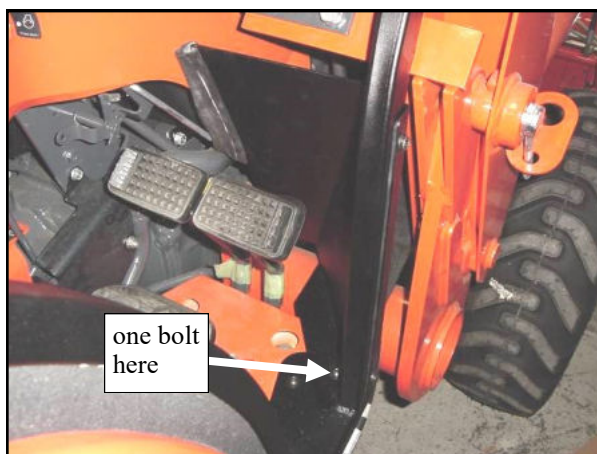

Fig. 8.2 (view from right side of tractor)



Fig. 9.2 (view from left rear side of tractor)

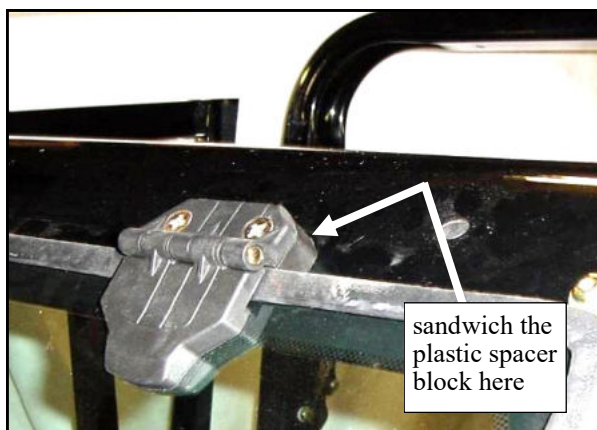

Fig. 9.1 (view from left front side of tractor)

10. ROOF

10.1 Per fig. 10.1, keep the windshield support tight against the side frame tubing (downward also) and tighten the two bolts (one per side). Use bar clamps as shown if necessary.

10.2 Use a Phillips head screwdriver to punch a hole through the headliner at all the covered bolt hole locations in the roof (11 places). Punch holes from the inside out to avoid having the headliner pull away from its glued surface.

10.3 Per fig. 10.3 and with assistance, install the roof oriented so the narrowest portion (with just the three bolt holes) is towards the rear of the tractor and fits between the ROPS. Use the following hardware: eleven 5/16 x 3/4" long hex flange bolts, eleven plastic washers and eleven flange locknuts. Flange locknuts to be on the inside of the cab. Note: the last holes to receive bolts should be the two rear corner holes (one per side). Install hardware and tighten all eleven roof bolts.

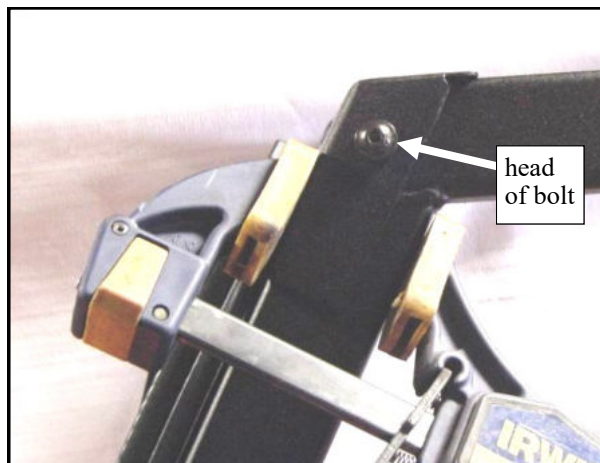

Fig. 10.1 (view from left side of tractor)

11. TIGHTEN ALL BOLTS

11.1 Per fig. 11.1, keep the cowl tight against the side frame tubing and tighten the bolts (two per side). Use bar clamps as shown if necessary.

11.2 Tighten all the other cab bolts at this time (including the floorboard bolts, roll bar bracket bolts, front leg bolts, etc.).



Fig. 10.3 (view from right side of tractor)

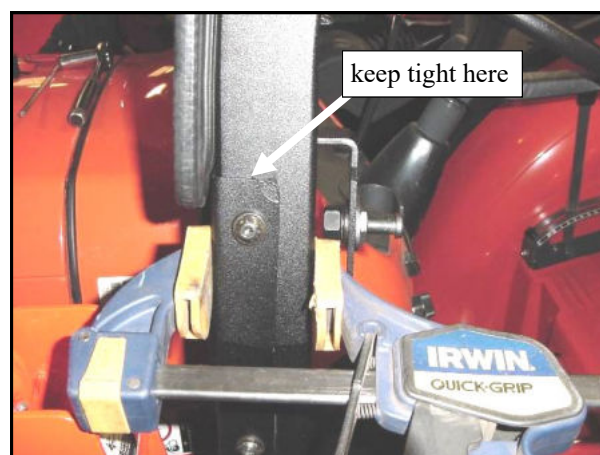

Fig. 11.1 (view from left side of tractor)

12. SOFT REAR CURTAIN

Only for standard cabs. Skip this step and proceed to step 13 below if installing a premium cab with a hard rear panel.

12.1 Per fig. 12.1, engage the four snaps on the rear curtain to the factory installed snaps on the upper rear support.

12.2 Per fig. 12.2, the long left and right vertical sides of the rear curtain are to be velcroed to the inside surface of the sheet metal. Note: for best adhesion, apply velcro to surfaces that are clean, dry, and at room temperature.

13. UNDER SEAT FILLER

13.1 Figures 13.1, 13.1a, and 13.1b show the underseat filler. Begin by doing a dry fit to get a feel for where all areas fit best. Start by lining up straight edge “a” with the bottom of the soft rear curtain (which has mating velcro) or the bottom of the hard rear panel (install the supplied mating velcro along the lower inside portion of the hard rear panel). Make sure the areas where the supplied self-adhesive hook velcro will be applied are clean and dry and at room temperature for best adhesion. Apply the corresponding velcro where deemed necessary and to match the velcro on the vinyl filler. **Note: There are a couple of different seat variations. If seat belts mount to seats, pass the filler under the seat belts as shown in figure 13.1a. If they mount to the transmission or fenders, pass the seat belts through the slots provided as shown in figure 13.1b.**

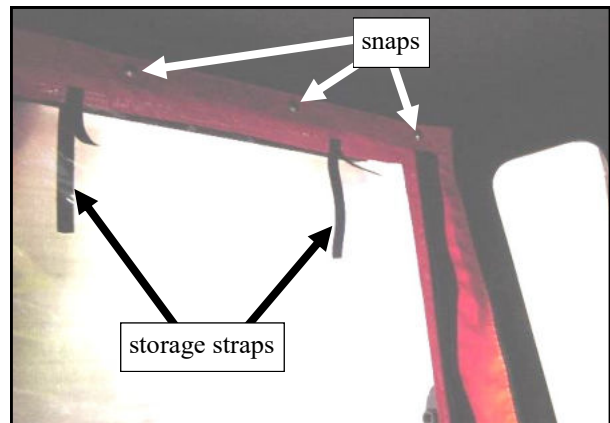

Fig. 12.1 (view from left side of tractor)



Fig. 12.2 (view from right side of tractor)

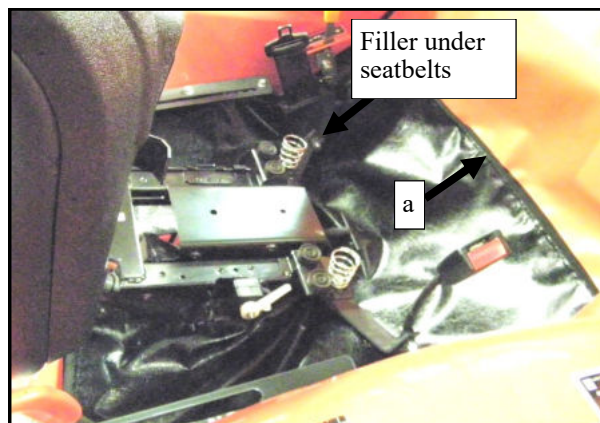

Fig. 13.1a (photo taken from left front side)

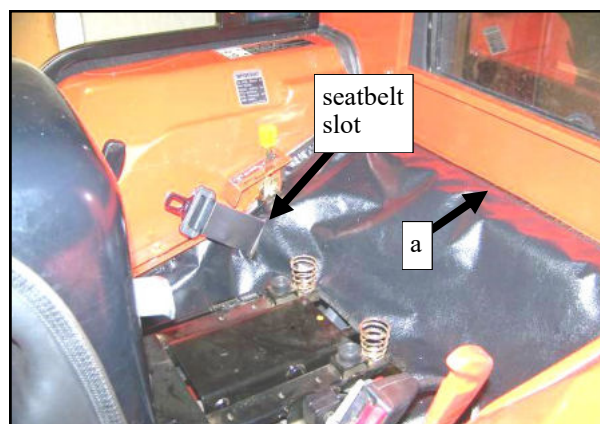

Fig. 13.1b (photo taken from left front side)



Fig. 13.1 (underseat filler)

13. UNDER SEAT FILLER (cont'd.)

13.2 Per figures 13.2 and 13.2a, the black, vinyl filler should remain below the O.E.M. control panels, drive markings, etc.. NOTE: on gear drive vehicles, cut the vinyl to suit the "H" shift pattern.

14. AIR INTAKE FILLERS

14.1 Fig. 14.1 shows the left and right air intake fillers. The two fillers are to be velcroed together in the center (mating velcro will be evident on the fillers) and this center seam should be lined up directly below the steering column. Begin by doing a dry fit to get a feel for where all areas fit best. Example: how much overlap is there on the inside surfaces of the front legs, etc.. The top straight edges shown at the very top of the photo are installed so they're up (approximately parallel to the top of the cowl). Make sure the areas where the supplied self-adhesive hook velcro will be applied are clean, dry, and at room temperature for best adhesion. Apply velcro to the tractor where deemed necessary and to suit. Note: keep the velcro above the "P" decal on the right side where indicated in fig. 14.1a.

NOTE: on gear drive vehicles, the shifter exits the transmission tunnel where the fillers are normally velcroed. Tucking them in front of the gear shift and attaching the rest of the fillers with velcro will make a good seal.



Fig. 13.2 (view of left side of tractor)



Fig. 13.2a (view of right side of tractor)



Fig. 14.1a (view from right rear side of tractor)

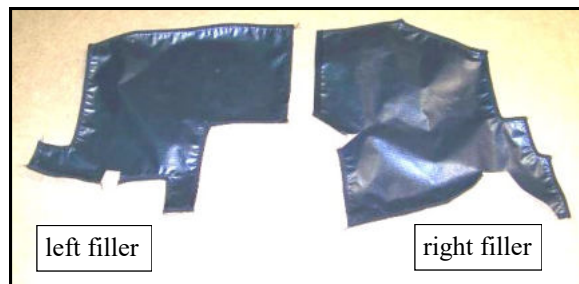

Fig. 14.1 (air intake fillers)

15. LOADER VALVE FILLER

15.1 Per fig. 15.1, install the orange vinyl filler oriented so the seam is outboard as shown (closest to the right side frame tube). Apply velcro where deemed necessary and to suit. Per fig. 15.1a, the lower outboard section of the vinyl filler is to be velcroed to the front face of the right side frame tube. Make sure the areas where the supplied self-adhesive hook velcro will be applied are clean, dry, and at room temperature for best adhesion.

16. LIGHTS

16.1 Per fig. 16.1, re-install the two orange hazard lights using the supplied extension wires and light mount (one per side) along with the following hardware: one 3/8" x 1" long hex head bolt, two flat steel washers, and one locknut. Tighten bolt. Repeat for right side of tractor.



Fig. 15.1 (view from right rear side of tractor)

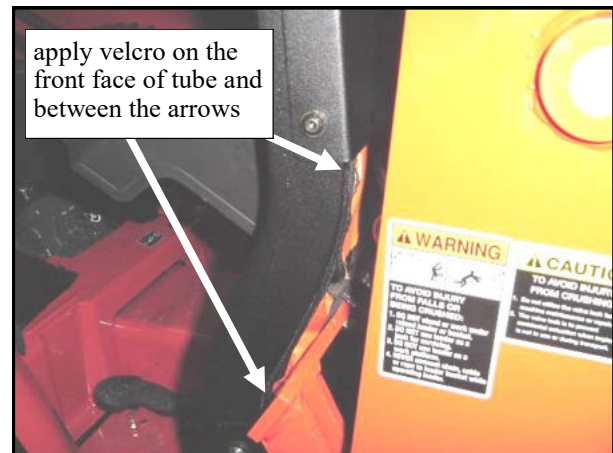

Fig. 15.1a (view from right front side of tractor)

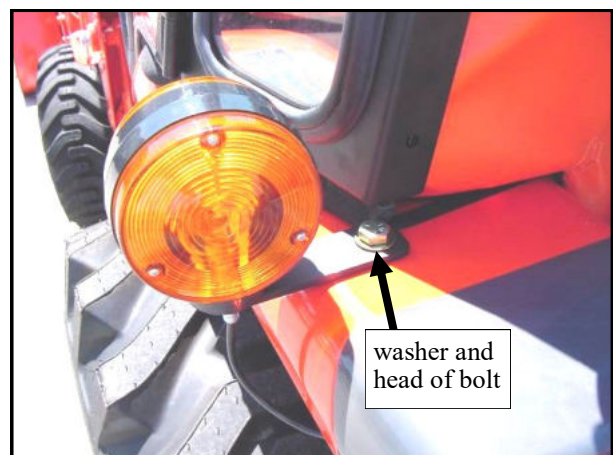

Fig. 16.1 (lights)

17. DOORS

17.1 Apply grease to the pin hinges. With assistance, re-install the doors onto the pin hinges. Work the doors back and forth until the hinges are completely seated.

Specific adjustments can be made per steps 17.2 and 17.3. Note: top of door should end up visually parallel with side of roof. Note: the door latch is a rotary type with two positions to close. Adjust door so that when fully closed door latch clicks **twice** for total engagement.

17.2 Per fig. 17.2, the large striker bolt and nut can be loosened and reset higher or lower or in or out for better engagement in the door latch assembly if necessary. Use two 19mm open end wrenches. Note: finger guard to end up being centered and facing inward.

17.3 Per fig. 17.3, the 1/4-20 flange hex head bolts on the door hinges can be loosened on the rear tube, or on the door itself, or in both places, in order to slightly rotate the door up or down as necessary for proper latch assembly and striker bolt engagement. Note: an assistant will be needed for this step. Keep the hinge sleeves fully seated on the pin hinges. Tighten all hinge bolts using caution to **not** over tighten. Over tightening will crush (damage) the structural tubing. **Torque to 40 inch/pounds.**

CAUTION: FOR SAFE OPERATION, DO NOT DRIVE WITH DOORS OPEN. MAKE SURE DOORS ARE CLOSED AND PROPERLY LATCHED WHEN DRIVING.

18. LUBRICATION

18.1 Once the doors are properly adjusted, lubrication (preferably grease) can be applied to the striker bolts and door latch assemblies. Re-apply periodically as needed (same goes for the door pin hinges as necessary).

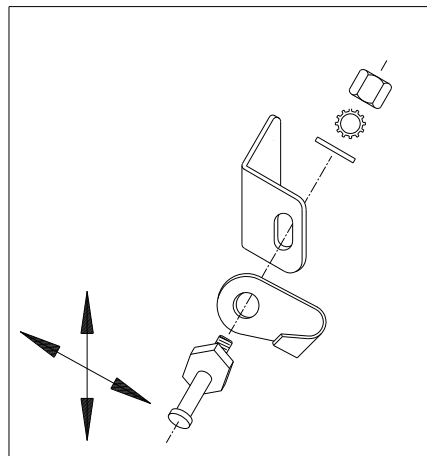

Fig. 17.2 (striker bolt)

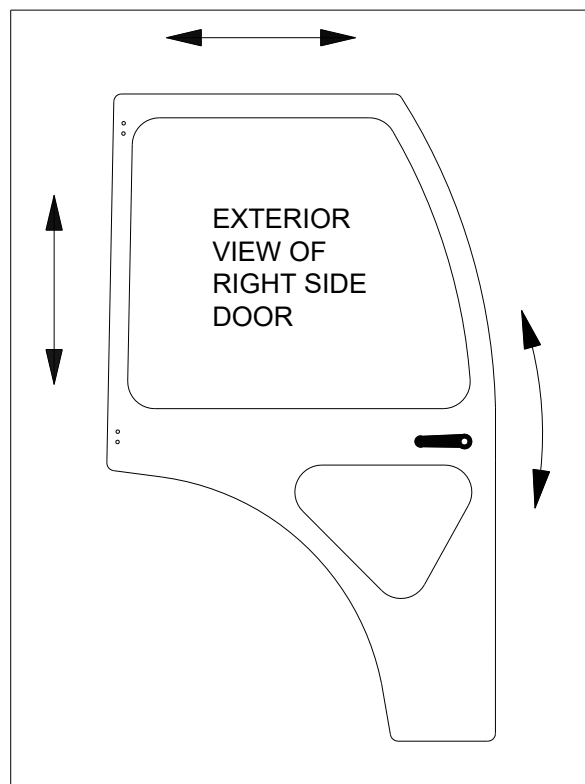

Fig. 17.3 (right side door)

19. FINISHING TOUCHES

- 19.1 Install the gas shock to the frame and door with the small piston end towards the door.
- 19.2 Peel protective film from any applicable windows.
- 19.3 Note: extra hardware has been provided in case they get lost. Discard extras such as washers, etc.
- 19.4 Install the front windshield wiper per the installation instructions included with the wiper kit.
- 19.5 Additional optional equipment available: Work Lights, Heater, Hard Rear Panel, and Rear Window Wiper.

20. CARE AND MAINTENANCE

- 20.1 Check and tighten hardware after 40 hours of operation. Periodically inspect and tighten hardware for the remainder of the unit's life.
- 20.2 Wash the painted surfaces of the unit with commercial automotive cleaning products.
- 20.3 Clean windows with glass cleaner.
- 20.4 Vinyl components should be washed with a mild solution of warm soapy water.
- 20.5 Clear vinyl can be easily scratched. Be careful cleaning frost or snow from rear curtain. Do not roll curtain in cold weather. The curtain becomes stiff and may crack. Keep curtain clean.

KUBOTA L3301 and L3901 PREMIUM CAB (p/n: 1KL39PR)

(more components shown on last two pages)

ROOF	QTY.	P/N
ORANGE	1	8SV-KL3201-O3

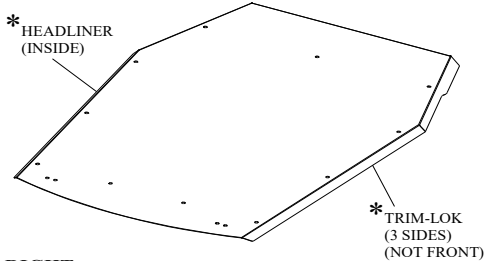

WINDSHIELD	QTY.	P/N
	1	8SV-102-00008

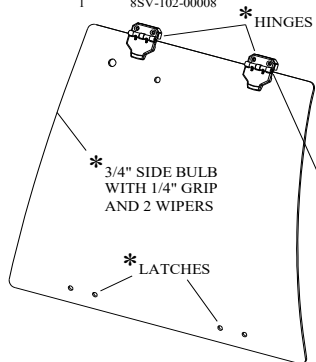

WINDSHIELD SUPPORT	QTY.	P/N
T-BLACK	1	8SV-KL3204-B4

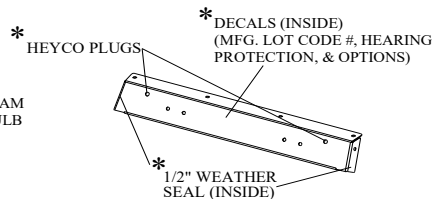

RIGHT LEG	QTY.	P/N
ORANGE	1	8SV-LK3210R-O3

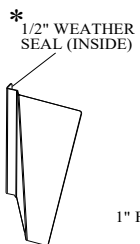

LEFT LEG	QTY.	P/N
ORANGE	1	8SV-104-00004-L

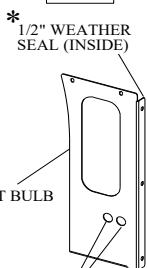

REAR PANEL	QTY.	P/N
ORANGE	1	8SV-106-00007

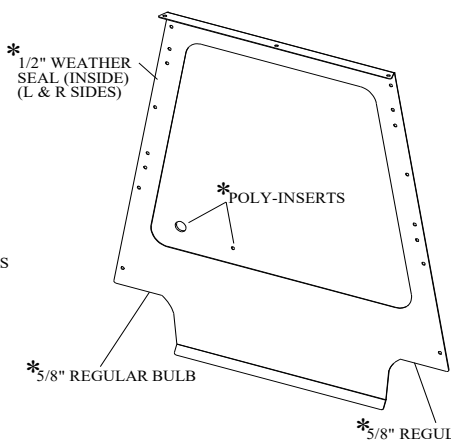

COWL	QTY.	P/N
ORANGE	1	8SV-105-00006

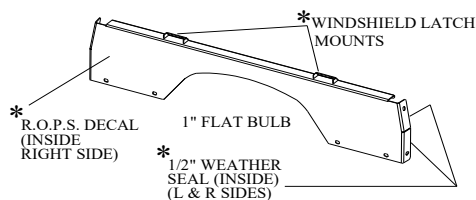

SIDE FRAMES	QTY.	P/N
T-BLACK	1L	8SV-KL32AS9L-B4
	1R	8SV-KL32AS9R-B4

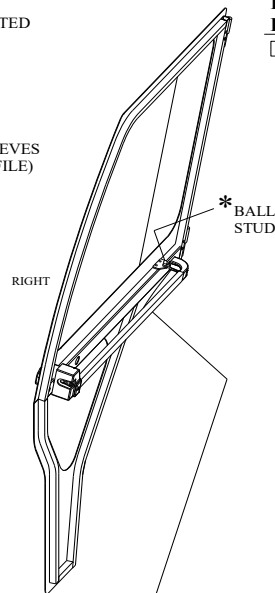
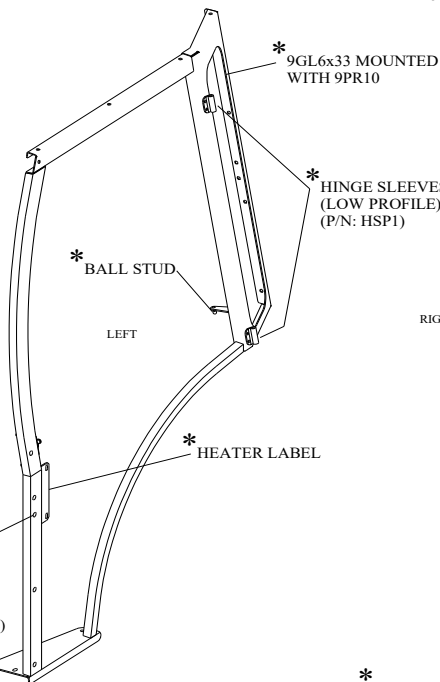
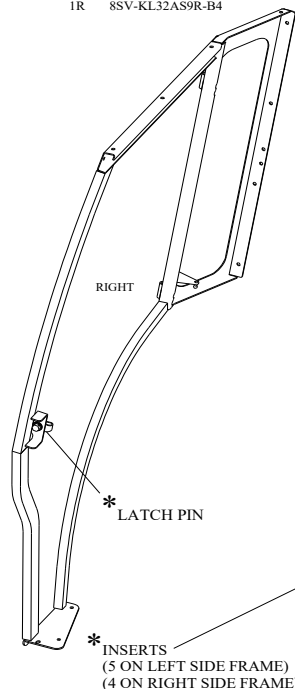

LIGHT MOUNT	QTY.	P/N
T-BLACK	2	8SV-KL3214-B4

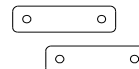

PREMIUM CAB DOORS	QTY.	P/N
ORANGE	1L	8SV-KL32AS7L-O3
	1R	8SV-KL32AS7R-O3

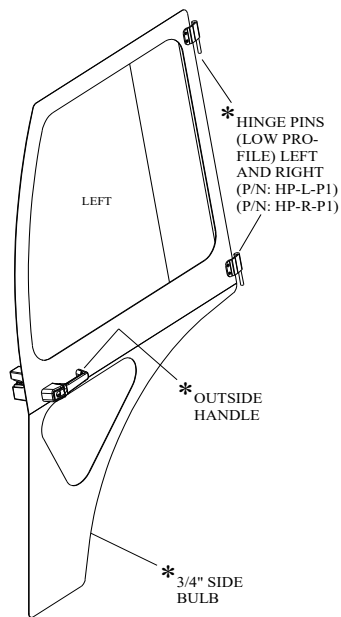

RUBBER TYPES:

TRIM-LOK



9PR01

3/4" SIDE BULB



9PR17

3/4" SIDE BULB W/ 1/4" GRIP & 2 WIPERS



9PR38

1" FLAT BULB



9PR05

REG-BULB



9PR02

1/2" WEATHER SEAL



9PR20

KUBOTA L3301 and L3901 (additional components for both cabs)

NOTE: THE TOP EIGHT (8) ITEMS ARE NOT SOLD SEPARATELY.
ONLY SOLD IN 4-PIECE KITS AS SHOWN AT THE BOTTOM OF THIS PAGE.

(more components shown on next page)

UPPER ROLL BAR MOUNT

	QTY.	P/N
T-BLACK	1L	-
	1R	-

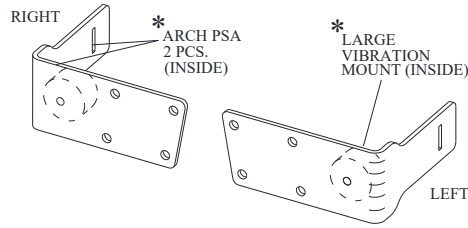

LOWER ROLL BAR MOUNT

	QTY.	P/N
T-BLACK	1L	-
	1R	-

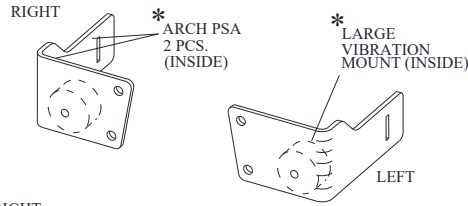

UPPER ROLL BAR BRACKET

	QTY.	P/N
T-BLACK	1L	-
	1R	-

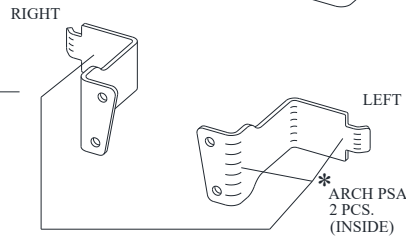

LOWER ROLL BAR BRACKET

	QTY.	P/N
T-BLACK	1L	-
	1R	-

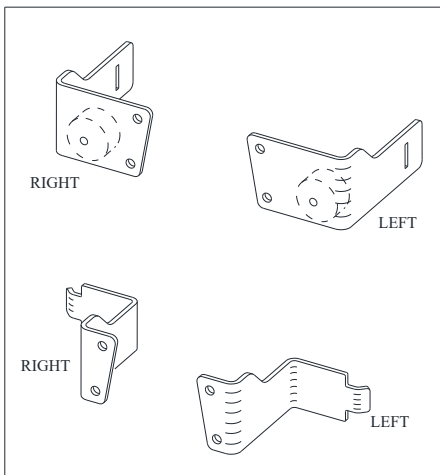
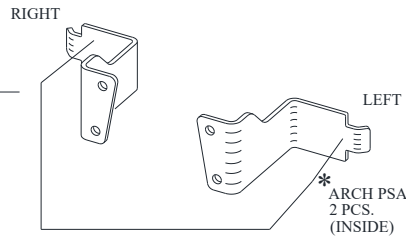

KIT SERVICE PART NO. AND DESCRIPTION:
LOWER ROLL BAR MOUNT SET P/N: 8SV-110-00012

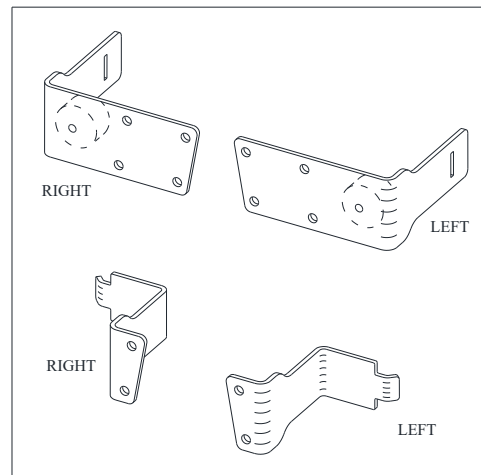

KIT SERVICE PART NO. AND DESCRIPTION:
UPPER ROLL BAR MOUNT SET P/N: 8SV-KL3212-B4

RUBBER TYPES:

ARCH PSA



9PR09

KUBOTA L3301 and L3901 (additional components for both cabs)

UNDER SEAT FILLER

QTY.	P/N
1	8SV-KL3215-VC

BLACK

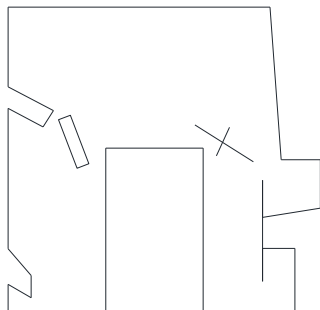

LOADER VALVE FILLER

QTY.	P/N
1	8SV-KL3216-VK

ORANGE

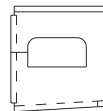

LEFT FRONT FILLER

QTY.	P/N
1	8SV-KL2817L-VC

BLACK

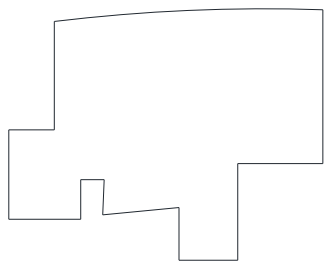

RIGHT FRONT FILLER

QTY.	P/N
1	8SV-KL2817R-VC

BLACK

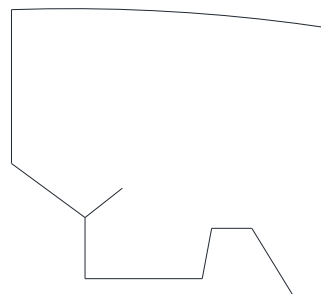

ADDITIONAL SERVICE PARTS

QTY.:	P/N:	DESCRIPTION:
1	8SV-P-00014	UPPER DOOR WINDOW, STD. CAB WITH RUBBER
1	8SV-GL27x32	REAR PANEL WINDOW ONLY WITH RUBBER & INSERTS
1	8SV-GL6x33	SIDE FRAME WINDOW WITH RUBBER
1	8SV-SWL32L	LEFT DOOR SLIDER WITH RUBBER
1	8SV-SWL32R	RIGHT DOOR SLIDER WITH RUBBER
1	8SV-L32LD	LOWER DOOR WINDOW WITH RUBBER
1	8SV-PGL32FL	FRONT LEG WINDOW WITH RUBBER
1	HWK-00018	HARDWARE KIT (CAB)
1	HWK-00019	HARDWARE KIT (REAR PANEL)
1	9SV-GS03	GAS SPRING - 10" LONG (SET OF 2)
1	9SV-HSLP	DOOR HINGE KIT - LOW PROFILE
1	9SV-DL02	DOOR LATCH KIT - NON-LOCKING WITH GRAB HANDLE
1	9SV-OHRL	OUTSIDE HANDLE ROTARY LATCH KIT
1	9SV-DL02	DOOR LATCH KIT - NON LOCKING WITH GRAB HANDLE (FOR A.S. ONLY)
1	9SV-IHRL	INSIDE HANDLE ROTARY LATCH KIT (FOR S.S. ONLY)
1	9SV-GH	GRAB HANDLE KIT
1	9SV-HWSS	WINDSHIELD HINGE KIT WITH SHORT SPACER
1	9SV-WL1	WINDSHIELD LATCH KIT 1