



**Kubota BX 70 Series Cab  
(fits BX2370, BX2670, and BX25D)  
(p/n: 1KBX70AS Steel Cab)  
(p/n: 1KBX70SS Vinyl Cab)**

The contents of this envelope are the property of the owner.  
Be sure to leave with the owner when installation is complete.

APPROXIMATE INSTALLATION TIME: 4 HOURS  
(excluding accessories)



Steel Cab Shown  
Standard equipment: Front Windshield Wiper.

Options available:  
Interior Rear View Mirror (not shown) (p/n: 9PM3)  
85 Degree Rear Wiper (20" Blade) (p/n: 9PWK8520F)  
3" x 5" Oval LED Front Work lights (p/n: 9LEDW2)  
Heater (p/n: 9PH20S18) (18 and 23 hp engines)  
Heater (p/n: 9PH20S40) (26 hp engine)  
LED Strobe Light (p/n: 9LEDS2)  
Exterior Side View Mirrors (not shown) (9PM5)  
Fuse Block Switch Panel (not shown) (9PSF1)  
Front Plow/Blade (not shown) (1KBXFELB)

Rev. D  
08/19/2016  
p/n: IM-1KBX70

## Kubota BX70 Series Hard Sided Cab (p/n: 1KBX70AS)

ROOF	QTY.	P/N
KUBOTA ORANGE	1	8SV-BX7001-03

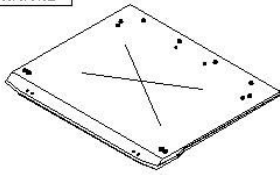

WINDSHIELD	QTY.	P/N
	1	8SV-CT02

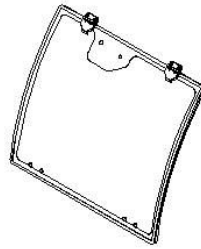

WINDSHIELD SUPPORT	QTY.	P/N
DARK KUBOTA GRAY	1	8SV-BX7003-G3

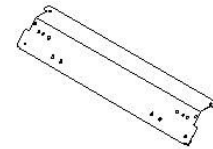

COWL	QTY.	P/N
KUBOTA ORANGE	1	8SV-BX7004-03

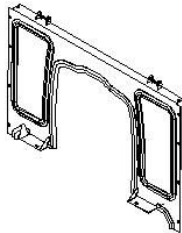

FUEL CAP SHROUD	QTY.	P/N
DARK KUBOTA GRAY	1	8SV-BX7012-G3

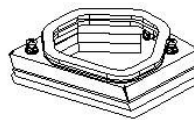

REAR PANEL	QTY.	P/N
KUBOTA ORANGE	1	8SV-BX7006-03

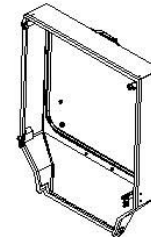

FUEL CAP COVER	QTY.	P/N
KUBOTA ORANGE	1	8SV-BX7013-03



ROPS MOUNT UPPER	QTY.	P/N
DARK KUBOTA GRAY	2	8SV-BX7010-G3

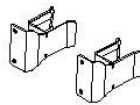

SIDE FRAMES	QTY.	P/N
DARK KUBOTA GRAY	1L	8SV-BX709L-G3
	1R	8SV-BX709R-G3

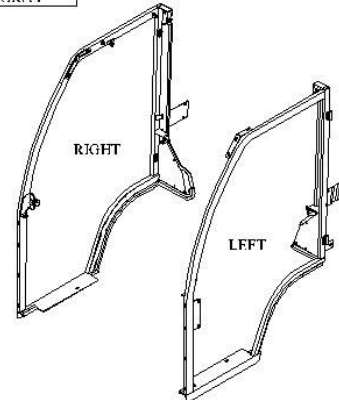

ROPS MOUNT LOWER	QTY.	P/N
DARK KUBOTA GRAY	1R & 1L	8SV-BX7011-G3

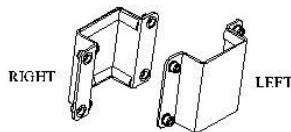

SMV MOUNTING BRACKET	QTY.	P/N
DARK KUBOTA GRAY	1	8SV-BX7014-G3



HINGE SPACER KIT	QTY.	P/N
	1	9SV-HWS



HINGE KIT	QTY.	P/N
	1	9SV-HDR1



HARD SIDED DOORS	QTY.	P/N
KUBOTA ORANGE	1L	8SV-BX70AS7L-03
	1R	8SV-BX70AS7R-03

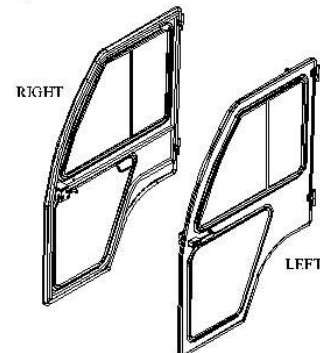

ADDITIONAL SERVICE PARTS		
QTY.	P/N	DESCRIPTION
1	8SV-GL28x31	REAR PANEL WINDOW
1	8SV-PGBX70C	COWL WINDOW
1	8SV-SWCCVL	LEFT DOOR SLIDER WITH RUBBER
1	8SV-SWCCVR	RIGHT DOOR SLIDER WITH RUBBER
1	8SV-BX70LDW	LOWER DOOR WINDOW WITH RUBBER
1	BX70-HWK	HARDWARE KIT (CAB)
1	9SV-GS02Q	QUICK RELEASE GAS SHOCK
1	9SV-GS06	GAS SHOCK (13-3/4") 500N
1	9SV-DHRL	OUTSIDE HANDLE ROTARY LATCH KIT
1	9SV-IHRL	INSIDE HANDLE ROTARY LATCH KIT
1	9SV-HSLP	WINDSHIELD HINGE KIT
1	9SV-WL1	WINDSHIELD LATCH KIT 1
1	9PWML10	WINDSHIELD WIPER MOTOR 110°
1	9PW820-FB	WIPER BLADE 20" - FLEX
1	8SV-BX7015-VC	AIR INTAKE COVER (BLACK VINYL)

RUBBER TYPES		
		WINDOW RUBBER 9SV-PR10-10
TRIM-LOK 9SV-PR11-20	ARCH PSA 9SV-PR13-10	1/2" WEATHER SEAL 9SV-PR20-10
3/4" SIDE BULB V/ 1/16" GRIP 9SV-PR17-20	5/8" ROUND BULB 9SV-PR12-15	5/8" SIDE BULB V/ 1/4" GRIP 9SV-PR23-15

## Kubota BX70 Series Soft Sided Cab (p/n: 1KBX70SS)

**ROOF** QTY. P/N

KUBOTA ORANGE 1 8SV-BX7001-G3

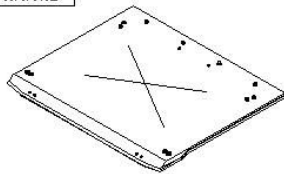

**WINDSHIELD** QTY. P/N

1 8SV-CT02

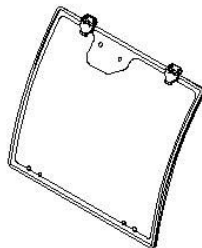

**WINDSHIELD SUPPORT** QTY. P/N

DARK KUBOTA GRAY 1 8SV-BX7003-G3

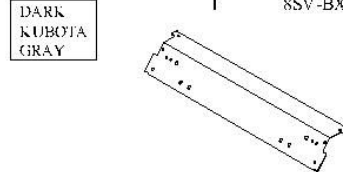

**COWL** QTY. P/N:

KUBOTA ORANGE 1 8SV-BX7004-G3

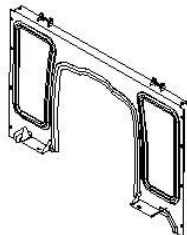

**FUEL CAP SHROUD** QTY. P/N

DARK KUBOTA GRAY 1 8SV-BX7012-G3

DARK KUBOTA GRAY

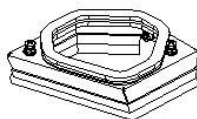

**REAR CURTAIN** QTY. P/N

BLACK VINYL 1 8SV-BX7006-VC

BLACK VINYL

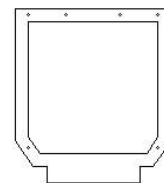

**FUEL CAP COVER** QTY. P/N

KUBOTA ORANGE 1 8SV-BX7013-G3

KUBOTA ORANGE



**ROPS MOUNT UPPER** QTY. P/N

DARK KUBOTA GRAY 2 8SV-BX7010-G3

DARK KUBOTA GRAY

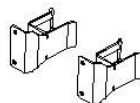

**SIDE FRAMES** QTY. P/N

DARK KUBOTA GRAY 1L 8SV-BX709L-G3  
1R 8SV-BX709R-G3

DARK KUBOTA GRAY

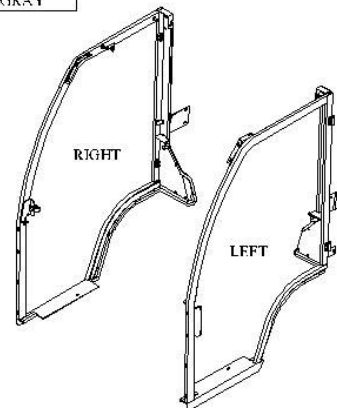

**ROPS MOUNT LOWER** QTY. P/N

DARK KUBOTA GRAY 1R & 1L 8SV-BX7011-G3

DARK KUBOTA GRAY

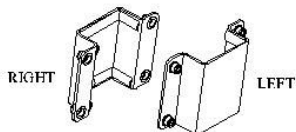

**SMV MOUNTING BRACKET** QTY. P/N

DARK KUBOTA GRAY 1 8SV-BX7014-G3

DARK KUBOTA GRAY



**HINGE SPACER KIT** QTY. P/N

1 9SV-HW'S



**HINGE KIT** QTY. P/N

1 9SV-HDR1



**SOFT SIDED DOORS** QTY. P/N

DARK KUBOTA GRAY AND ORANGE VINYL 1L 8SV-BX70SS7L-VK  
1R 8SV-BX70SS7R-VK

DARK KUBOTA GRAY AND ORANGE VINYL

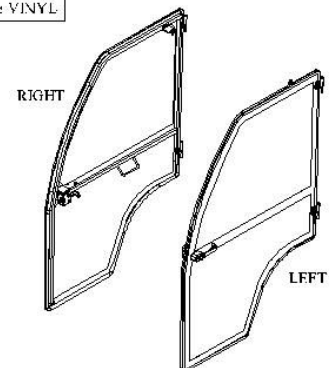

ADDITIONAL SERVICE PARTS		
QTY.:	P/N:	DESCRIPTION:
1	8SV-PGBX70C	COWL WINDOW
1	BX70-HWK	HARDWARE KIT (CAB)
1	9SV-DS04	DOOR TETHER (14 INCH W/ HARDWARE)
1	9SV-GS06	GAS SHOCK (13-3/4") 500N
1	9SV-DHRL	OUTSIDE HANDLE ROTARY LATCH KIT
1	9SV-IHRL	INSIDE HANDLE ROTARY LATCH KIT
1	9SV-HSLP	WINDSHIELD HINGE KIT
1	9SV-WL1	WINDSHIELD LATCH KIT 1
1	9PWM110	WINDSHIELD WIPER MOTOR 110°
1	9PWB20-FB	WIPER BLADE 20" - FLEX
1	8SV-BX7015-VC	AIR INTAKE COVER (BLACK VINYL)

RUBBER TYPES:		
TRIM-LOK 9SV-PR01-20	ARCH PSA 9SV-PR09-10	WINDOW RUBBER 9SV-PR10-10
3/4" SIDE BULB W/ 1/16" GRIP 9SV-PR17-20	5/8" ROUND BULB 9SV-PR02-15	1/2" WEATHER SEAL 9SV-PR20-10
		5/8" SIDE BULB W/ 1/4" GRIP 9SV-PR23-15