



John Deere Gator XUV 825i S4 Cab

(p/n: 1GTRXUV4 Steel Cab with Doors)

The contents of this envelope are the property of the owner.
Be sure to leave with the owner when installation is complete.

APPROXIMATE INSTALLATION TIME: 5 HOURS
(excluding accessories)



Standard equipment: Windshield Wiper.

Options available:

- Interior Switch Panel Console (p/n: 1GXV2SP)
- Interior Rear View Mirror (p/n: 9PM3)
- 5 LED Flat Work Lights (p/n: 9LEDW4)
- Heater (p/n: 9PH20S53)
- LED Strobe Light (p/n: 9LEDS2)

Rev. B
10/9/2014

JOHN DEERE GATOR 825i S4 CAB (p/n: 1GTRXUV4)

FRONT ROOF

QTY: P/N:
1 8SV-GXV4F01-B4

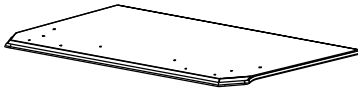

REAR ROOF

QTY: P/N:
1 8SV-GXV4B01-B4

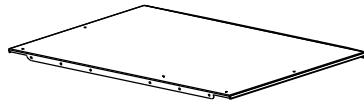

WINDSHIELD SUPPORT

QTY: P/N:
1 8SV-GXV203-B4

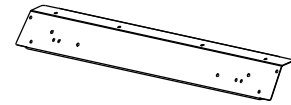

FRONT RIGHT PANEL

QTY: P/N:
1 8SV-GXV415R-B4

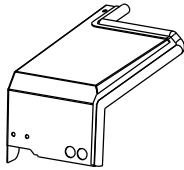

FUEL TANK SHROUD

QTY: P/N:
1 8SV-GXV411-B4

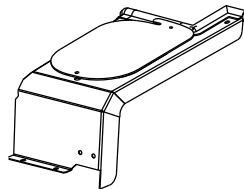

BACK RIGHT PANEL

QTY: P/N:
1 8SV-GXV416R-B4

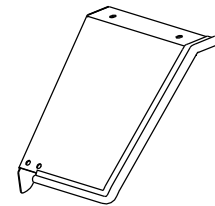

SIDE PANELS

QTY: P/N:
1L 8SV-GXV208L-B4
1R 8SV-GXV208R-B4

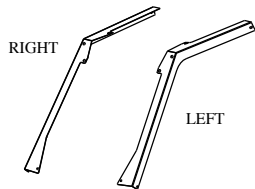

FRONT CLAMPS

QTY: P/N:
1L 8SV-GXV05L-B4
1R 8SV-GXV05R-B4

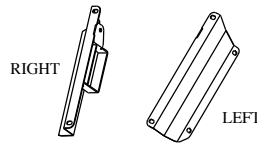

FRONT LEGS

QTY: P/N:
1L 8SV-GXV204L-B4
1R 8SV-GXV204R-B4

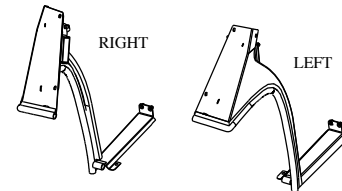

MIDDLE LEGS

QTY: P/N:
1L 8SV-GXV4MLL-B4
1R 8SV-GXV4MLR-B4

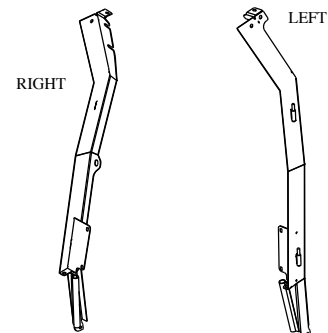

ADDITIONAL SERVICE PARTS		
QTY	P/N:	DESCRIPTION:
2	8SV-PGGXV4BUDW	UPPER REAR DOOR WINDOW WITH RUBBER
2	8SV-PGGXV4BLDW	LOWER REAR DOOR WINDOW WITH RUBBER
1	8SV-SWGXVVRP	REAR PANEL SLIDING WINDOW WITH RUBBER
1	8SV-SWGXVDRL	LEFT DOOR SLIDER WITH RUBBER
1	8SV-SWGXVDRR	RIGHT DOOR SLIDER WITH RUBBER
2	8SV-PGGXVLDW	LOWER FRONT DOOR WINDOW WITH RUBBER
2	8SV-GXV2DRHL-B4	LEFT DOOR HINGES (1 UPPER + 1 LOWER)
2	8SV-GXV2DRHR-B4	RIGHT DOOR HINGES (1 UPPER + 1 LOWER)
1	GXV4-HWK	HARDWARE KIT (CAB)
2	9SV-GS04Q	GAS SPRING - 14 7/16" LONG QUICK RELEASE (DOOR SET OF 2)
1	9SV-GS02	GAS SPRING - 12 3/8" LONG (WINDSHIELD SET OF 2)
2	9SV-OHRL	OUTSIDE HANDLE ROTARY LATCH KIT
2	9SV-IHRL	INSIDE HANDLE ROTARY LATCH KIT
1	9SV-HSLP	WINDSHIELD HINGE KIT
1	9SV-WL2	WINDSHIELD LATCH KIT 2
1	9PWM110	WINDSHIELD WIPER MOTOR 110"
1	9PWA14/16	WIPER ARM (14"-16")
1	9PWB20-FB	WIPER BLADE 20" - FLEX
1	8SV-PCGXVFTSC	FUEL TANK COVER (POLYCARBONATE)

RUBBER TYPES:	3/4" SIDE BULB W/ 1/16" GRIP	5/8" ROUND BULB	1" ROUND BULB	1/2" WEATHER SEAL	TRIM-LOK	1/8" x 1" FOAM TAPE	ARCH PSA	WINDOW RUBBER	BALL CAGE RUBBER
	9SV-PR17-20	9SV-PR02-15	9SV-PR19-10	9SV-PR20-10	9SV-PR01-10	9SV-PR39-5	9SV-PR09-10	9SV-PR10-10	9SV-PR11-10

JOHN DEERE GATOR 825i S4 CAB (p/n: 1GTRXUV4)

BACK LEFT PANEL

QTY: P/N:

1 8SV-GXV416L-B4

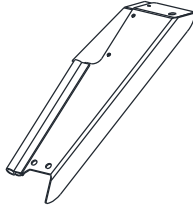

BACK FLOORBOARDS

QTY: P/N:

1L 8SV-GXV418L-B4
1R 8SV-GXV418R-B4

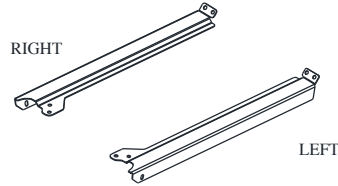

BACK HEADERS

QTY: P/N:

1L 8SV-GXV417L-B4
1R 8SV-GXV417R-B4

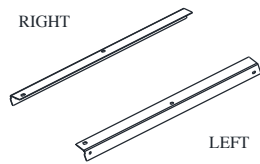

WINDSHIELD

QTY: P/N:

1 8SV-GXV02

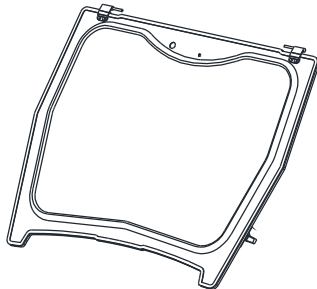

REAR PANEL

QTY: P/N:

1 8SV-GXV206-B4

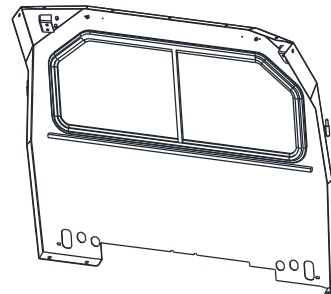

FRONT DOORS

QTY: P/N:

1L 8SV-GXV27L-B4
1R 8SV-GXV27R-B4

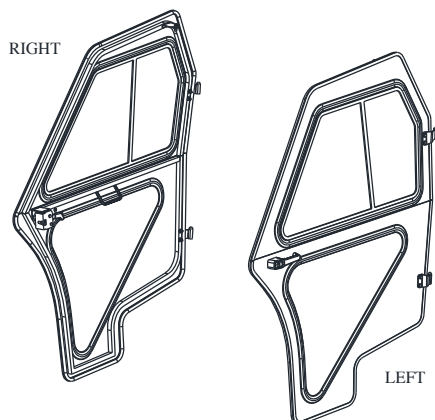

REAR DOORS

QTY: P/N:

1L 8SV-GXV47BL-B4
1R 8SV-GXV47BR-B4

