



John Deere Gator XUV S4 Cab

p/n: 1GTRXUV4 (Steel Cab with Doors)
(fits the following models: 825i S4, 825M S4, 855D S4, and 855M S4)

The contents of this envelope are the property of the owner.
 Be sure to leave with the owner when installation is complete.

APPROXIMATE INSTALLATION TIME: 5 HOURS
 (excluding accessories)



Standard equipment: Windshield Wiper.

Options available:



Interior Switch Panel Console (p/n: 1GXV2SP)
 Interior Rear View Mirror (p/n: 9PM3)
 5 LED Flat Work Lights (p/n: 9LEDW4)
 Heater (p/n: 9PH20S53)
 LED Strobe Light (p/n: 9LEDS2)

Rev. C
 12/04/2025

NOTICE

Cabs, blades, and general accessories add additional weight to the base vehicle. Deduct the accessory's total weight from the vehicle's rated capacity including driver and passenger.

⚠ WARNING *Exposure to Carbon Monoxide can Cause illness, serious injury or death. Never operate vehicle if suspicious of Carbon Monoxide. Inspect exhaust system for leaks monthly. Leaks can result from loose connections, corrosion, cracks or other damage to the exhaust manifold. If leaks are found, repair or replace exhaust system. Do not use vehicle until repair or replacement is complete.*

⚠ WARNING	
Serious Injury or Death	
	This cab enclosure does not provide protection from rollover or other accidents.
	This cab enclosure does not provide protection from flying objects including golf balls.
	This cab enclosure does not provide protection from lightning. When lightning threatens take cover and do not operate vehicle.

GENERAL INFORMATION BEFORE YOU START

HELPFUL HINTS:

- A. Refer to parts diagram toward the back of this manual to help identify parts during the assembly process.
- B. To assist with the cab installation, leave all bolts loose for later adjustment unless otherwise specified.
- C. Read and understand all instructions before beginning.
- D. Apply a clear silicone sealant to seal any minor gaps that may occur due to vehicle variations.
- E. Use caution to avoid damaging the factory installed threaded inserts. Begin the bolt engagement by hand to guard against potential cross threading.

TOOLS REQUIRED:

Set of Standard Sockets
 Ratchet
 Set of Standard Open End Wrenches
 10mm Open End Wrench
 Phillips Head Screwdriver
 Grease
 Snips

NOTICE

RE: ROOFTOP AIR CONDITIONING KIT

If you are installing the Curtis Rooftop Air Conditioning kit with this cab, you must install the A/C drive kit (compressor, alternator, etc.) prior to installing this cab.

Please proceed to installation of those components from that kit before proceeding with the installation of this cab.

Note: Installation of the A/C drive kit after the cab has been installed will require removal of the rear half of the cab in order to access the necessary locations in the engine bay to install the A/C drive kit.

1. REAR PANEL

1.1 Open/lift the dump bed.

Note: If you are planning to install rear work lights or 4-way flashers, it is easier to pre-install the lights at this time. Please see the instructions in that kit for proper installation steps.

1.2 Per fig. 1.2, remove and save (2) rear seat back bolts behind the rear center seat.

1.3 With assistance, lift the rear panel into place as shown in figures 1.3 and 1.4. The triangular bends should match up to the angles at the top of the OPS (Operator Protective Structure).

1.4 Per fig. 1.4, fasten the top of the rear panel to the vehicle using the hardware listed below. (leave finger tight)

Qty. Hardware Type

- | | |
|---|----------------------------|
| 2 | 5/16-18 x 3/4" Flange Bolt |
| 2 | 5/16-18 Nylock Flange Nuts |

1.5 Per fig. 1.3, fasten the bottom of the rear panel at the two outer corners using the hardware listed below. (leave finger tight)

Qty. Hardware Type

- | | |
|---|----------------------------|
| 2 | 5/16-18 x 3/4" Flange Bolt |
| 2 | 5/16-18 Nylock Flange Nuts |

1.6 Per fig. 1.2, reinstall the two rear seat back bolts removed in step 1.2.

1.7 Tighten the rear panel in this order:
 1 - Rear seat back bolts (step 1.6)
 2 - Lower corner bolts (step 1.5)
 3 - Upper corner bolts (step 1.4)

1.8 Replace dump bed

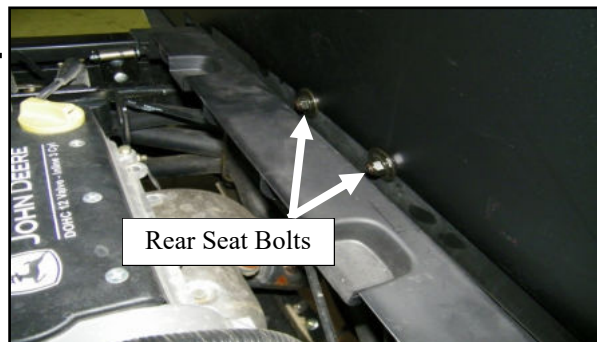

Fig. 1.2 (view from rear of passenger's side)

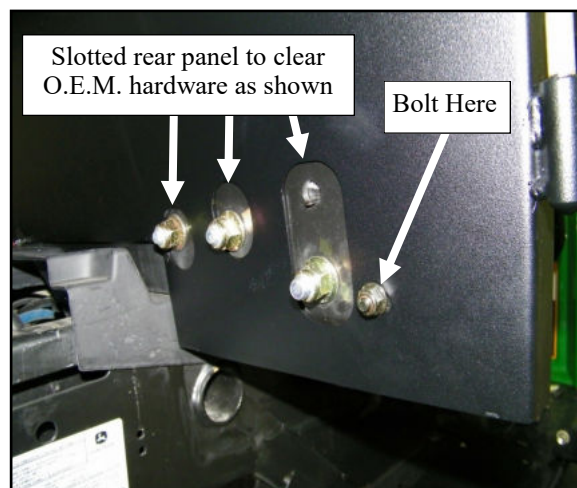

Fig. 1.3 (view from rear of passenger's side)



Fig. 1.4 (view of rear passenger's side)

2. FRONT LEGS

2.1 Align the front leg with the front fender on the vehicle, as shown in figure 2.1. Per figure 2.1a, fasten through the hole in the floorboard.

Install finger tight at this time.

Qty. Hardware Type

- | | |
|---|----------------------------|
| 1 | 5/16-18 x 3/4" Flange Bolt |
| 1 | 5/16-18 Nylock Flange Nuts |

2.2 Align the front clamps as shown in figure 2.2 with the ball stud at the top. Fasten to the front leg using the hardware listed below. **Note the orientation of the hardware, as shown in figure 2.2. Install finger tight at this time.**

Qty. Hardware Type

- | | |
|---|----------------------------|
| 3 | 5/16-18 x 3/4" Flange Bolt |
| 3 | 5/16-18 Nylock Flange Nuts |

Do not install a bolt through the top hole, as this will be installed in a later step.

2.3 Repeat for opposite side.



Fig. 2.1 (view of passenger's side)

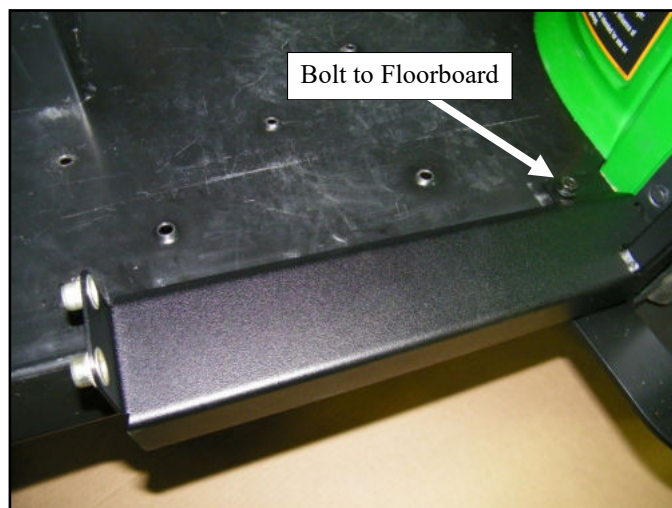

Fig. 2.1a (view of passenger's side)

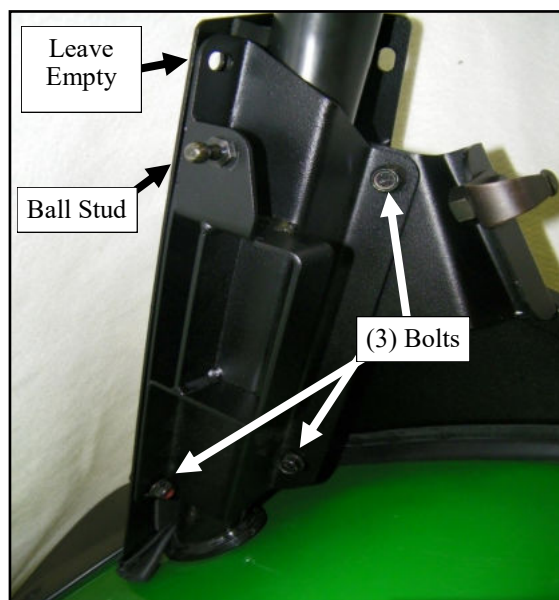

Fig. 2.2 (view of passenger's side)

3. REAR FLOORBOARDS

3.1 Fasten rear floorboards to bottom of vehicle, using the hardware listed below, as shown in figure 3.1. **Install finger tight at this time.**

Note: All floorboard bolts need to remain loose until filler panels & fuel tank shroud are installed.

Qty. Hardware Type

2	5/16-18 x 3/4" Flange Bolt
2	5/16-18 Nylock Flange Nuts

4. MIDDLE LEGS

4.1 Per fig. 4.1, loosen the (2) rear OPS bolts shown. They do not need to be removed. Slide the middle leg between the front and rear OPS so that the slots align with the OPS bolts. Leave bolts loose.

4.2 Per fig. 4.2, fasten the center portion of the middle leg to the back of the OPS at the seat belt using the hardware listed below. **Install finger tight at this time.**

Qty. Hardware Type

2	5/16-18 x 3/4" Flange Bolt
2	5/16-18 Nylock Flange Nuts

4.3 Per fig. 4.3, fasten the lowest hole on the middle leg to the floorboard installed in step 3.1 using the hardware listed below.

Qty. Hardware Type

1	5/16-18 x 3/4" Flange Bolt
1	5/16-18 Nylock Flange Nuts

4.4 Tighten the three lower bolts and the two at the top of the OPS at this time.

4.4 Repeat for opposite side.

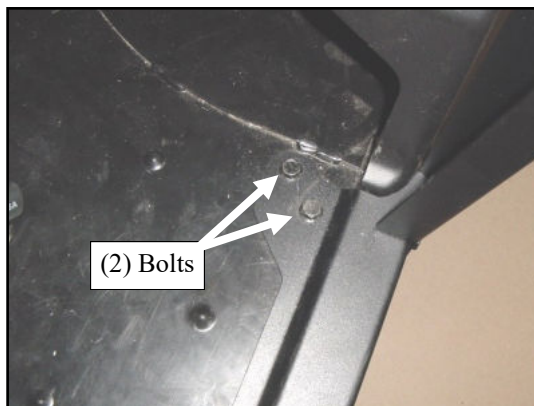

Fig. 3.1 (view of rear passenger's side floorboard)



Fig. 4.1 (view of middle passenger's side OPS)

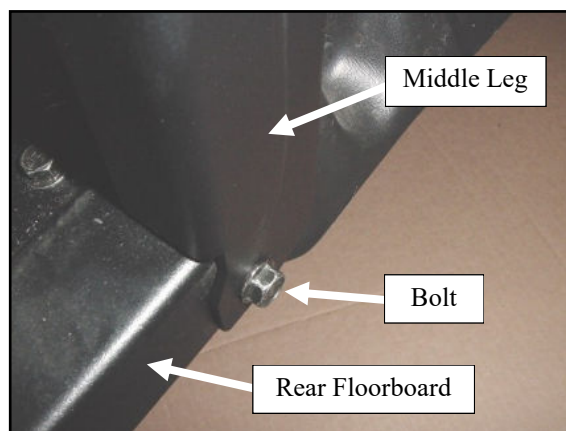

Fig. 4.3 (view of passenger's side floorboard)

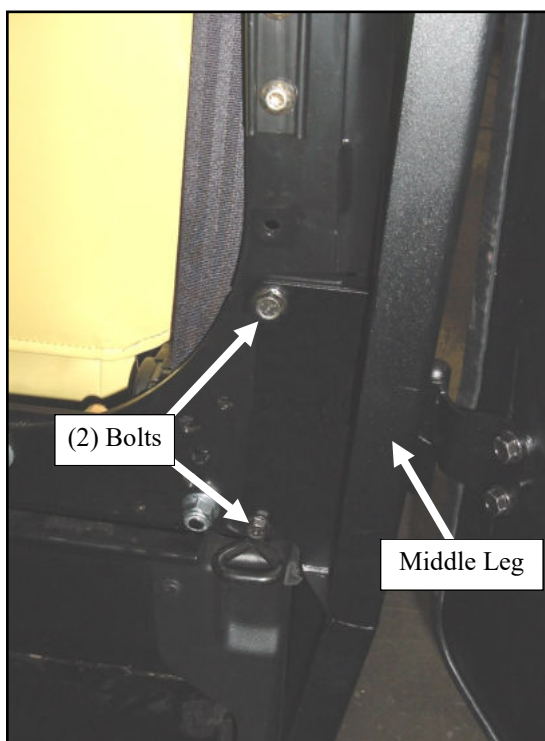

Fig. 4.2 (view of passenger's side)

5. FRONT SIDE PANEL

Note: Use caution to avoid damaging the factory installed threaded inserts on the rear panel. Begin the bolt engagement by hand to guard against potential cross-threading.

5.1 Align the front side panel to the front leg, as shown in figure 5.1. Fasten to the front leg using the hardware listed below. **Install finger tight at this time.**

Qty. Hardware Type

- | | |
|---|----------------------------|
| 2 | 5/16-18 x 3/4" Flange Bolt |
| 2 | 5/16-18 Nylock Flange Nuts |

5.2 Fasten front side panels to the middle panel using the hardware listed below, as shown in Figure 5.2.

Tighten one screw per side.

Qty. Hardware Type

- | | |
|---|----------------------------|
| 1 | 5/16-18 x 3/4" Flange Bolt |
|---|----------------------------|

5.3 Tighten the front clamp (installed in step 2.2) and side panel at this time. Be sure to push the front leg down to get a good seal against the vehicle fender.

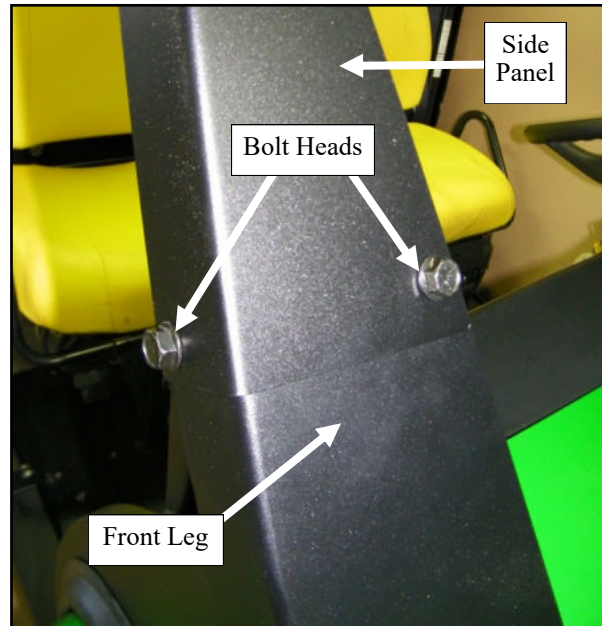

Fig. 5.1 (view of passenger's side)

6. REAR HEADER

6.1 Per fig. 6.1, align the rear edge of the header with the top edge of the rear panel and install the rear bolt. **Install finger tight at this time.**

Qty. Hardware Type

- | | |
|---|----------------------------|
| 1 | 5/16-18 x 3/4" Flange Bolt |
|---|----------------------------|

6.2 Per fig. 5.2, fasten the rear header to the middle leg.

Qty. Hardware Type

- | | |
|---|----------------------------|
| 1 | 5/16-18 x 3/4" Flange Bolt |
|---|----------------------------|

6.3 Tighten both bolts at this time.

6.4 Repeat for opposite side.

Note: Verify slot in middle leg, between rear header and front side panel, is clear prior to tightening bolts. (see Figure 5.2)

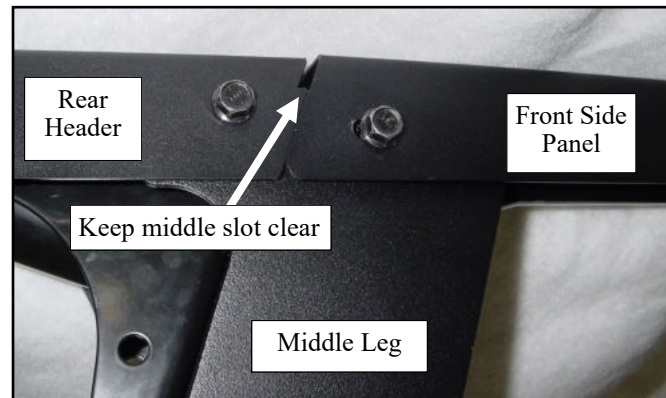

Fig. 5.2 (view of passenger's side)

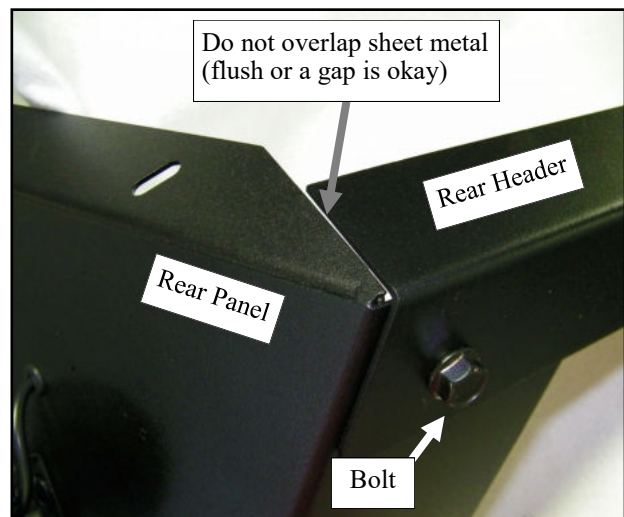

Fig. 6.1 (view of passenger's side)

7. WINDSHIELD

7.1 With assistance, orient the windshield support as shown in figure 7.1. Fasten to the side panels using the hardware listed below. **Tighten the screws at this time.**

Qty. Hardware Type

4 5/16-18 x 3/4" Flange Bolt

7.2 Set the windshield onto the vehicle and twist the latches to hold it into place. Slide the hinge sleeves onto the windshield hinge pins, oriented as shown in figure 7.2. Fasten using the hardware listed below. **Note: Install both the steel and rubber fender washers on the inside of the cab as shown in fig. 7.2a. Install finger tight at this time.**

Qty. Hardware Type

4 1/4-20 x 3/4" Flange Bolts

4 Rubber Fender Washers

4 Steel Fender Washers

4 1/4-20 Nylock Flange Nuts

7.3 Unlatch the latches on the windshield and adjust the windshield up or down to achieve the optimal seal against the hood. Re-engage the latches to hold it in the correct location.

7.4 Tighten the hinge sleeves. Ref. fig 7.2a.

7.5 With assistance, open the windshield and attach the short gas springs to the ball studs. Orient the springs so that the thin rod end is down as shown in figure 7.5.

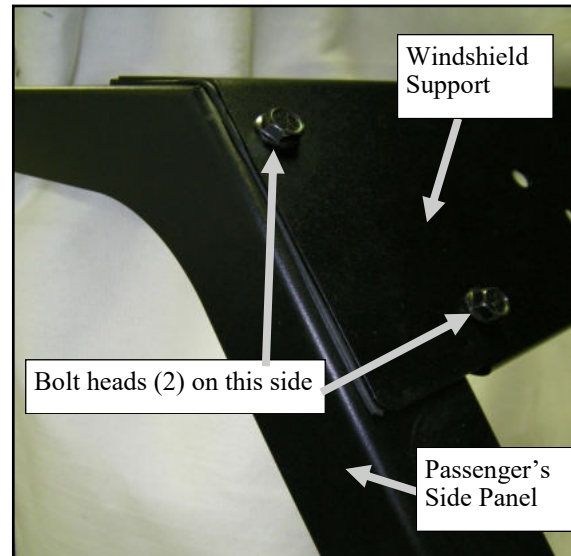

Fig. 7.1 (view of passenger's side)

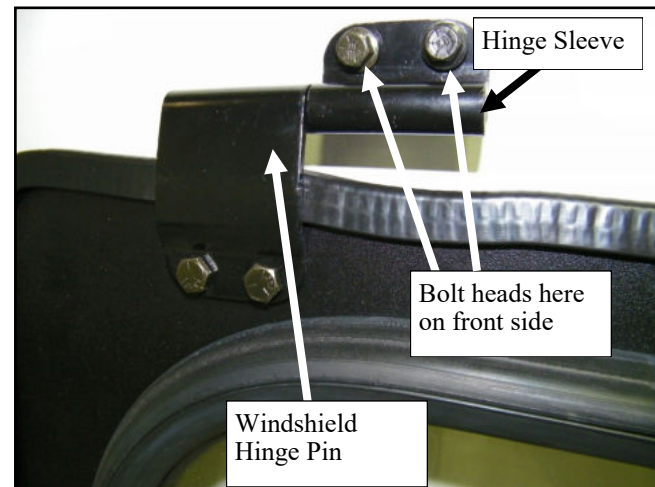

Fig. 7.2 (view of passenger's side)

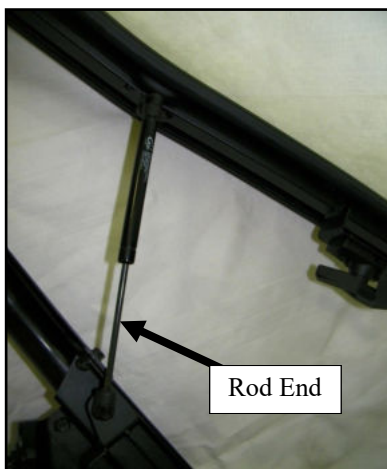

Fig. 7.5 (view of driver's side)



Fig. 7.2a (view of driver's side)

NOTICE:

If you are installing an A/C roof, please go back to the installation instructions from that kit at this time. Complete the A/C kit installation, then move on to Step 9 on the next page of this manual.

If you are installing the standard steel roof kit, please proceed with step 8 below.

8. FRONT AND REAR ROOF

Note: If you are planning to install front work lights or 4-way flashers, it is easier to pre-install the lights at this time. Please see the instructions in that kit for proper installation steps.

8.1 Before installing either roof, use a screwdriver to poke holes through the headliner (13 locations total). This will make installation easier. Poke the holes from the headliner side up through the hole in the roof to avoid having the headliner pull away from its glued surface.

8.2 Fasten the front edge of the front roof to the windshield support using the hardware listed below. Nylon sealing washers should be against the outer surface of the roof. **Install finger tight at this time.**

Qty. Hardware Type

- 4 5/16-18 x 3/4" Flange Bolt
- 4 5/16-18 Nylock Flange Nuts
- 4 5/16 Nylon Washers

8.3 Fasten the front roof to the OPS using the hardware listed below. The fender washers should be on top of the roof with the rubber washer against the roof to provide a seal. **Install finger tight at this time.**

Qty. Hardware Type

- 2 5/16-18 x 2-3/4" Flange Bolt
- 2 5/16-18 Nylock Flange Nuts
- 2 5/16 Steel Fender Washers
- 2 5/16 Rubber Fender Washers

8.4 Secure front and rear roof halves together using the hardware listed below, as shown in Figure 8.4. **Install finger tight at this time.**

Qty. Hardware Type

- 7 5/16-18 x 3/4" Flange Bolt
- 7 5/16-18 Nylock Flange Nuts

8.5 Fasten the remainder of the rear roof using the hardware listed below. **Install finger tight at this time.**

Qty. Hardware Type

- 9 5/16-18 x 3/4" Flange Bolt
- 9 5/16-18 Nylock Flange Nuts
- 9 5/16 Nylon Washers

8.6 Tighten all roof bolts at this time.



Fig. 8.4 (view of bolts between roof halves)

9. FUEL TANK SHROUD

9.1 Install the fuel tank shroud as shown in figure 9.1. Loosely fasten to the middle panel using the hardware listed below. **Do not tighten at this time.**

Qty. Hardware Type
1 5/16-18 x 3/4" Flange Bolt

9.2 Fasten to the vehicle floorboard using the hardware listed below. **Do not tighten at this time.**

Qty. Hardware Type
2 5/16-18 x 3/4" Flange Bolt
2 5/16-18 Nylock Flange Nuts

9.3 Fasten to the inserts at the back of the front leg using the hardware listed below. Tighten these bolts first and then go back and tighten the bolt installed in step 9.2 and then 9.1.

Qty. Hardware Type
2 5/16-18 x 3/4" Flange Bolt

9.4 The clear fuel cover pivots on the front screw / fender washer set up and swings outward off of the rear bolt for easy fuel tank access.

10. FRONT RIGHT PANEL

10.1 Install the filler on passenger's side as shown in figure 10.1. Loosely fasten to the rear panel using the hardware listed below.

Qty. Hardware Type
2 5/16-18 x 3/4" Flange Bolt

10.2 Fasten to the vehicle floorboard using the hardware listed below. **Do not tighten at this time.**

Qty. Hardware Type
2 5/16-18 x 3/4" Flange Bolt
2 5/16-18 Nylock Flange Nuts

10.3 Fasten to the inserts at the back of the front leg using the hardware listed below. Tighten these bolts first and then go back and tighten the bolts installed in step 10.2 and then 10.1.

Qty. Hardware Type
2 5/16-18 x 3/4" Flange Bolt

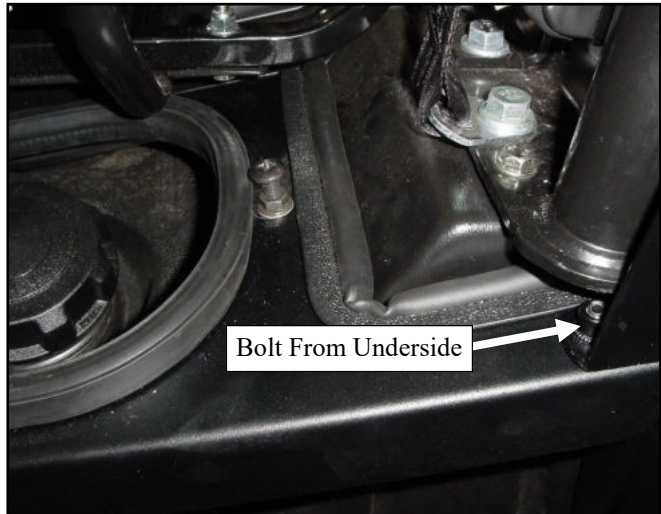

Fig. 9.1 (view of fuel tank shroud)

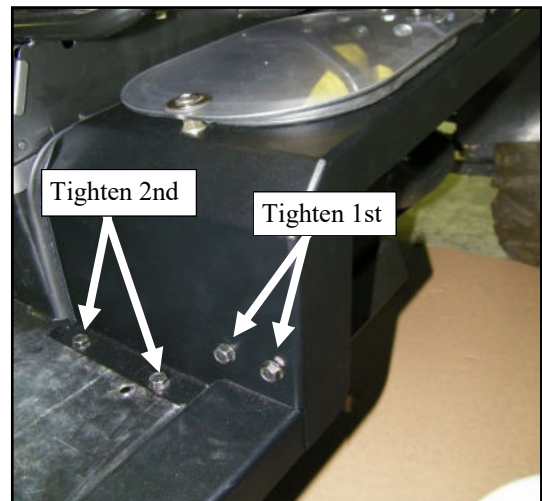

Fig. 9.2 (view of fuel tank shroud)

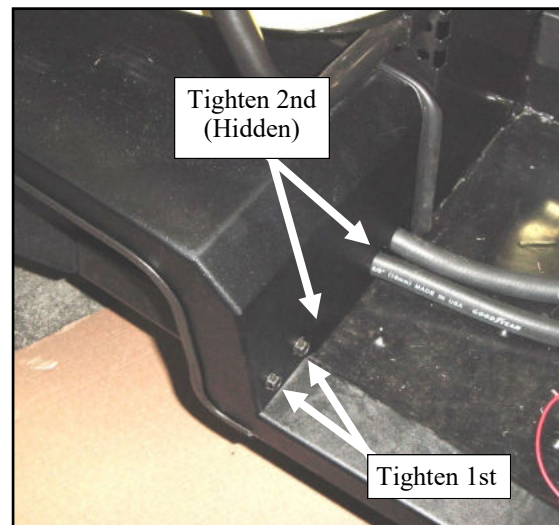

Fig. 10.1 (view of air intake cover)

11. BACK LEFT PANEL

11.1 Install the rear driver-side shroud as shown in figure 11.1. Loosely fasten to the rear panel using the hardware listed below. **Do not tighten at this time.**

Qty. Hardware Type

1 5/16-18 x 3/4" Flange Bolt

11.2 Fasten to the vehicle floorboard using the hardware listed below. **Tighten all bolts at this time.**

Qty. Hardware Type

2 5/16-18 x 3/4" Flange Bolt

2 5/16-18 Nylock Flange Nuts

12. BACK RIGHT PANEL

12.1 Install the rear shroud on passenger's side as shown in figure 12.1. Loosely fasten to the rear panel using the hardware listed below. **Do not tighten at this time.**

Qty. Hardware Type

2 5/16-18 x 3/4" Flange Bolt

12.2 Fasten to the vehicle floorboard using the hardware listed below. **Tighten all bolts at this time.**

Qty. Hardware Type

2 5/16-18 x 3/4" Flange Bolt

2 5/16-18 Nylock Flange Nuts

12.3 Tighten all floorboard bolts (installed in steps 2.1 and 3.1) at this time.

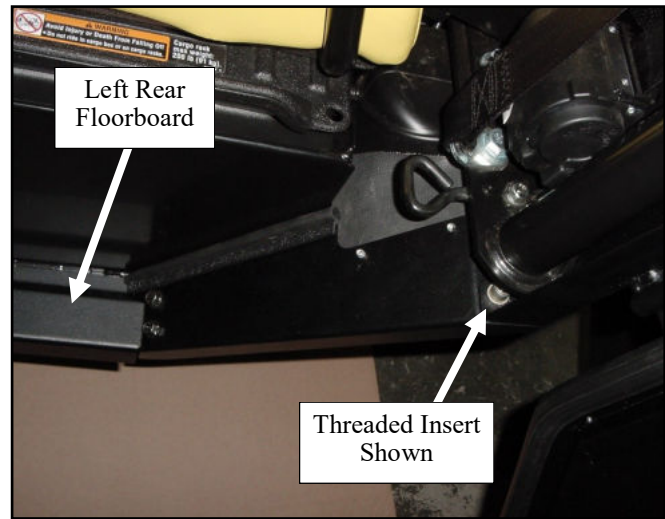

Fig. 11.1 (view of driver's side rear shroud)

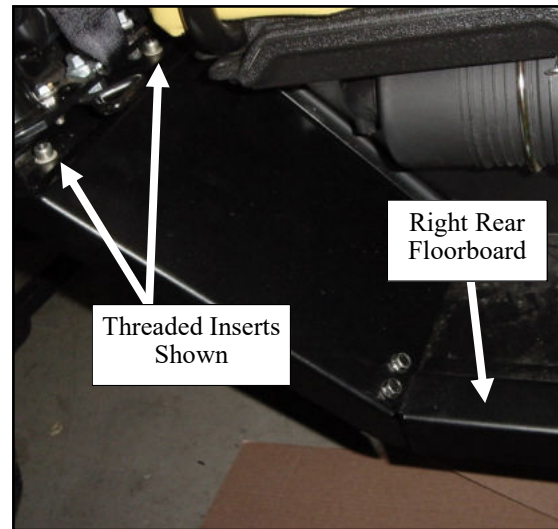

Fig. 12.1 (view of passenger's side rear shroud)

13. DOORS

13.1 Install four ball studs to the OPS (two on each side, front & back) as shown in figure 13.1.

Qty. Hardware Type

4	5/16-18 Ball Studs
4	5/16-18 Nylock Flange Nuts
4	5/16 SAE Steel Washers

13.2 Prior to installing the doors, apply grease to the door hinge pins on the rear panel and middle leg.

13.3 Install the eight brass washers onto the pins. See figure 13.3.

13.4 With assistance, install the door onto the hinge pins. If necessary, adjust the latch on the door (front to back) and/or the pin on the leg (up and down) until a “double click” is achieved. Continue to adjust the engagement as necessary until you get the door to close with “two” clicks which is confirmation that the door is fully closed and secure enough to drive. If the door is not sitting evenly on the vehicle, the hinge bolts can be loosened and re-adjusted.

13.5 Install the gas spring after the door is fully adjusted. Attach the large end to the ball stud installed in figure 13.5. The thin rod end should be attached to the door.
Note: The large end has a quick detach tab on it allowing the door to be removed without the use of tools.

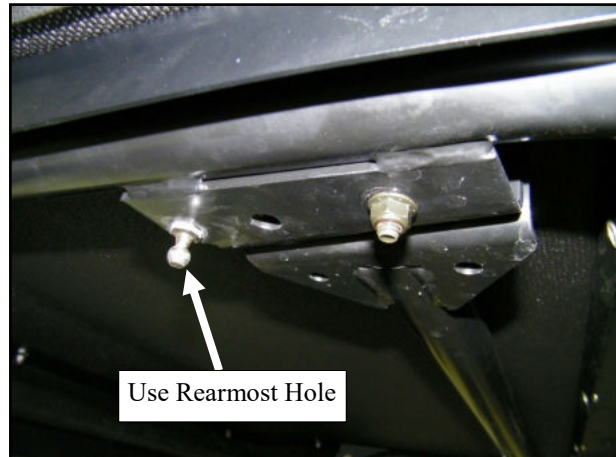

Fig. 13.1 (view of ball stud, front passenger's side)

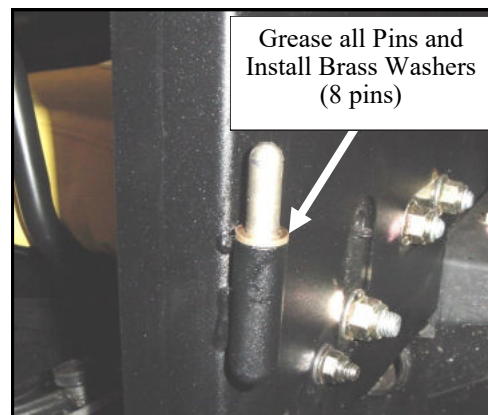

Fig. 13.2 (view of hinge pin)

Troubleshooting the door

Condition:

Door latch and striker pin does not line up (up and down)
Door latch and striker pin does not line up (front to back)
Door is not sitting even on vehicle.

Explanation/Solution

Move striker pin on front leg up or down.
Move latch on door forwards or backwards.
Loosen hinge bolts, realign door, retighten hinge bolts.

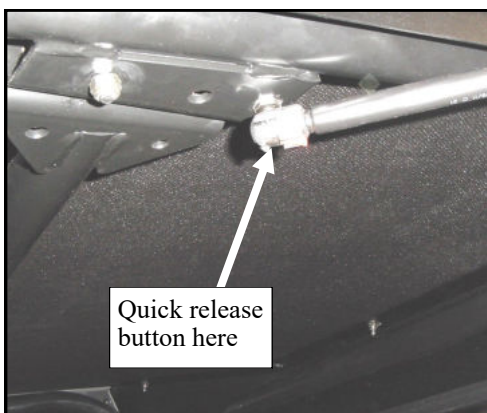

Fig. 13.5 (view of gas spring, driver's side)



Fig. 13.3 (view of brass washer)

14. INSTALL WIPER

14.1 Install the wiper per the included installation manual. Be sure to follow the instructions for installing through sheet metal and not glass. The cable ties included can be used to secure the wires. If you are installing a switch panel then you do not need to run a wire for the wiper. A power source is provided on the panel.

15. FINISHING TOUCHES

15.1 Install nut covers on the interior locknuts that are fastened to the (2) 2-3/4" long screws per fig. 15.1. Repeat for opposite side.

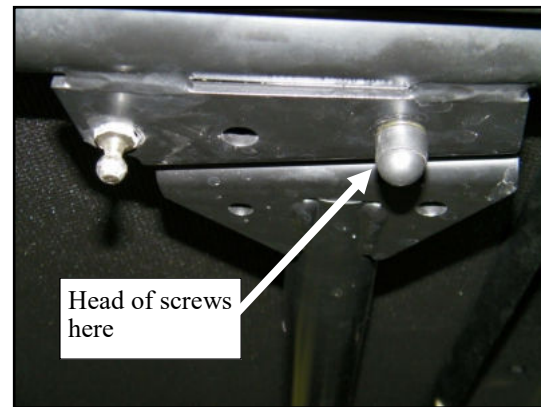

Fig. 15.1 (view of passenger's side)

16. CARE AND MAINTENANCE

16.1 Check and tighten hardware after 40 hours of operation. Periodically inspect and tighten hardware for the remainder of the unit's life.

16.2 Wash with a mild soap or detergent using your bare hands to free or dislodge any caked-on dirt or other foreign particles.

16.3 Be sure to regularly grease door hinge pins. Also lubricate moving parts in the door latches.

FRONT ROOF

QTY: P/N:
1 8SV-GXV4F01-B4

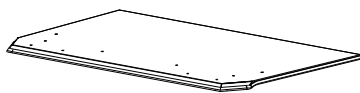

REAR ROOF

QTY: P/N:
1 8SV-GXV4B01-B4

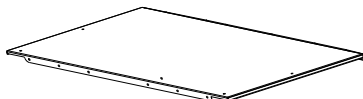

WINDSHIELD SUPPORT

QTY: P/N:
1 8SV-GXV203-B4

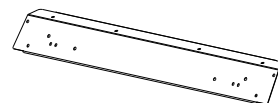

FRONT RIGHT PANEL

QTY: P/N:
1 8SV-GXV415R-B4

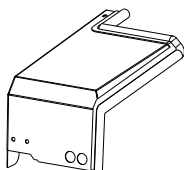

FUEL TANK SHROUD

QTY: P/N:
1 8SV-GXV411-B4

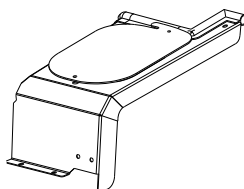

BACK RIGHT PANEL

QTY: P/N:
1 8SV-GXV416R-B4

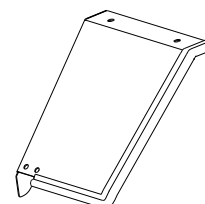

SIDE PANELS

QTY: P/N:
1L 8SV-GXV208L-B4
1R 8SV-GXV208R-B4

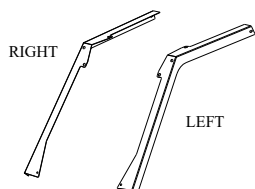

FRONT CLAMPS

QTY: P/N:
1L 8SV-GXV05L-B4
1R 8SV-GXV05R-B4

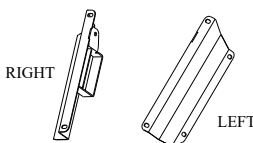

FRONT LEGS

QTY: P/N:
1L 8SV-GXV204L-B4
1R 8SV-GXV204R-B4

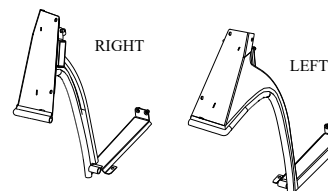

MIDDLE LEGS

QTY: P/N:
1L 8SV-GXV4MLL-B4
1R 8SV-GXV4MLR-B4

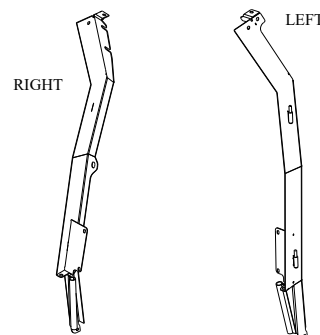

ADDITIONAL SERVICE PARTS		
QTY	P/N:	DESCRIPTION:
2	8SV-PGGXV4BUDW	UPPER REAR DOOR WINDOW WITH RUBBER
2	8SV-PGGXV4BLDW	LOWER REAR DOOR WINDOW WITH RUBBER
1	8SV-SWGXVRP	REAR PANEL SLIDING WINDOW WITH RUBBER
1	8SV-SWGXDRL	LEFT DOOR SLIDER WITH RUBBER
1	8SV-SWGXDRL	RIGHT DOOR SLIDER WITH RUBBER
2	8SV-PGGXVLDW	LOWER FRONT DOOR WINDOW WITH RUBBER
2	8SV-GXV2DRHL-B4	LEFT DOOR HINGES (1 UPPER + 1 LOWER)
2	8SV-GXV2DRHR-B4	RIGHT DOOR HINGES (1 UPPER + 1 LOWER)
1	GXV4-HWK	HARDWARE KIT (CAB)
2	9SV-GS04Q	GAS SPRING - 14 7/16" LONG QUICK RELEASE (DOOR SET OF 2)
1	9SV-GS02	GAS SPRING - 12 3/8" LONG (WINDSHIELD SET OF 2)
2	9SV-OHRL	OUTSIDE HANDLE ROTARY LATCH KIT
2	9SV-IHRL	INSIDE HANDLE ROTARY LATCH KIT
1	9SV-HSLP	WINDSHIELD HINGE KIT
1	9SV-WL2	WINDSHIELD LATCH KIT 2
1	9PWM110	WINDSHIELD WIPER MOTOR 110"
1	9PWA14/16	WIPER ARM (14"-16")
1	9PW20-FB	WIPER BLADE 20" - FLEX
1	8SV-PCGXVFTSC	FUEL TANK COVER (POLYCARBONATE)

RUBBER TYPES:	3/4" SIDE BULB W/ 1/16" GRIP	5/8" ROUND BULB	1" ROUND BULB	1/2" WEATHER SEAL	TRIM-LOK	1/8" x 1" FOAM TAPE	ARCH PSA	WINDOW RUBBER	BALL CAGE RUBBER
	9SV-PR17-20	9SV-PR02-15	9SV-PR19-10	9SV-PR20-10	9SV-PR01-10	9SV-PR39-5	9SV-PR09-10	9SV-PR10-10	9SV-PR11-10

BACK LEFT PANEL

QTY: P/N:

1 8SV-GXV416L-B4

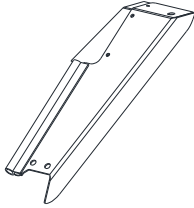

BACK FLOORBOARDS

QTY: P/N:

1L 8SV-GXV418L-B4
1R 8SV-GXV418R-B4

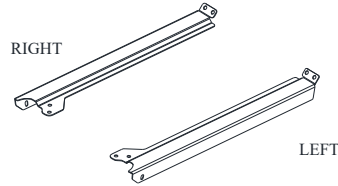

BACK HEADERS

QTY: P/N:

1L 8SV-GXV417L-B4
1R 8SV-GXV417R-B4

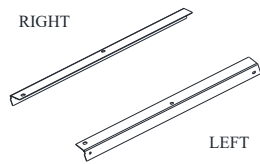

WINDSHIELD

QTY: P/N:

1 8SV-GXV02

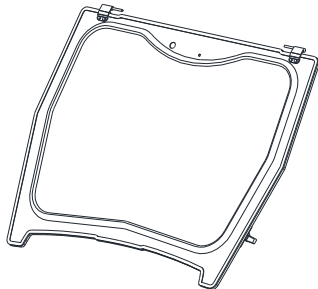

REAR PANEL

QTY: P/N:

1 8SV-GXV206-B4

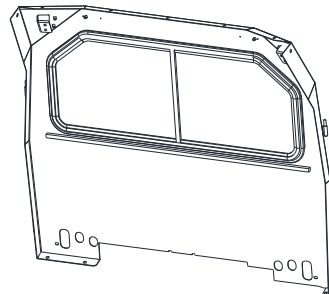

FRONT DOORS

QTY: P/N:

1L 8SV-GXV27L-B4
1R 8SV-GXV27R-B4

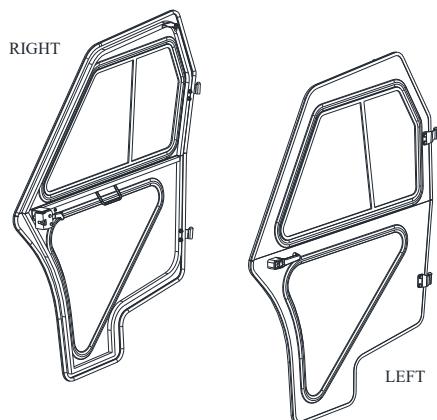

REAR DOORS

QTY: P/N:

1L 8SV-GXV47BL-B4
1R 8SV-GXV47BR-B4

