

CAB INSTALLATION INSTRUCTIONS

JOHN DEERE GATOR TS, TX, TE, and TH
HARD SIDED CAB KIT (p/n: 1GTS1AS)
SOFT SIDED CAB KIT (p/n: 1GTS1SS)
(fits model years 2005 - present)

The contents of this envelope are the property of the owner.
Be sure to leave with the owner when installation is complete.



NOTE: Hard Sided Cab shown with optional work lights and strobe light.

DESIGN CONCEPT

Curtis cabs feature an assembly of parts designed for your vehicle which require adjustment and alignment of components to accommodate vehicle variations and provide proper weather protection. For accurate installation, proper operation, and years of satisfaction, please read and understand the installation instructions.

From all of us at Curtis, we thank you for choosing our product.

| |
|---|
|  NOTICE |
| Curtis Cabs, blades and general accessories add additional weight to the base vehicle. All Curtis accessory weights are listed in product brochures. Deduct the accessory's total weight from the vehicle's rated capacity and never exceed the vehicle's rated capacity including driver and passenger. |

WARNING Exposure to Carbon Monoxide can Cause illness, serious injury or death. Never operate vehicle if suspicious of Carbon Monoxide. Inspect exhaust system for leaks monthly. Leaks can result from loose connections, corrosion, cracks or other damage to the exhaust manifold. If leaks are found, repair or replace exhaust system. Do not use vehicle until repair or replacement is complete.

CAB INSTALLATION **BEFORE YOU START**

HELPFUL REMINDERS:

- A. Refer to parts diagram toward the back of this manual to help identify parts during the assembly process.
- B. To assist with the cab installation, leave all bolts loose for later adjustment unless otherwise specified.
- C. Read and understand all instructions before beginning.
- D. Plastic washers have been supplied to provide a weather seal under the heads of all exterior bolts. The plastic washer should be installed under each bolt head directly against the outside cab surface. Care should be taken not to over tighten the fasteners and damage the plastic washer. Also use metal washers as required.
- E. Apply a clear silicone sealant to seal any minor gaps that may occur due to vehicle variations.

TOOLS REQUIRED:

Set of standard and metric sockets and open end wrenches
One 3/8" Drive Ratchet
One 3/16" Allen Wrench
Two Phillips Head Screwdrivers (one large and one small)
Grease
Drill
13/32" Drill Bit
Scissors

1. MODEL TH ONLY

1.1 If installing the cab on this six wheel vehicle, remove the middle wheel on each side as shown in figure 1.1. NOTE: the TH model (shown) is the only model that has a fender behind the seats.

2. DUMP BED

2.1 Lift the dump bed.

3. FRONT FENDERS

3.1 Remove five (5) original equipment sheet metal screws from underneath the plastic fender in the locations shown in figure 3.1. Repeat for opposite side. This vehicle preparation is to allow the installation of the front brackets in the next step. Save all hardware for re-installation later.

4. FRONT BRACKETS

4.1 Install the driver's side front bracket as shown in fig. 4.1. The rear bolt shown will be a 5/16 x 3/4" long carriage bolt. Use a steel washer and locknut on the inside (not shown). The other bolt used to hold the front bracket in place will be the re-installation of one of the original equipment sheet metal screws from underneath the plastic fender. See location "a" in fig. 4.1.

4.2 To install the front bracket on the passenger's side, pivot the glove box out of the way by removing the two (2) Phillips head screws holding it in place. Save these two screws for re-installation later. Install the washer and locknut onto the carriage bolt as shown in figure 4.2.



Fig. 1.1
(view from passenger's side)



Fig. 3.1
(view from driver's side)

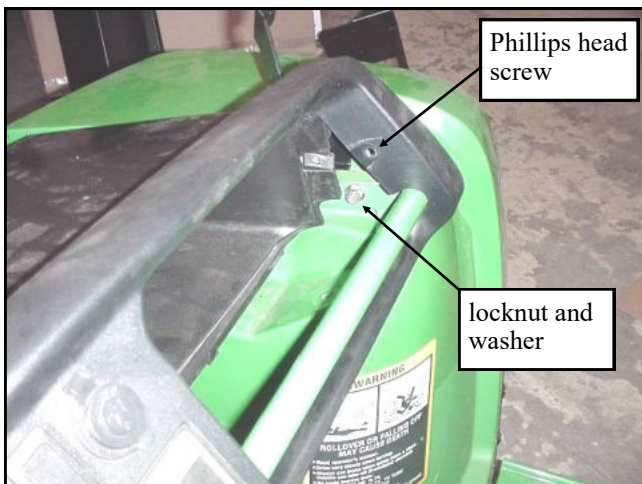

Fig. 4.2
(view from driver's side)

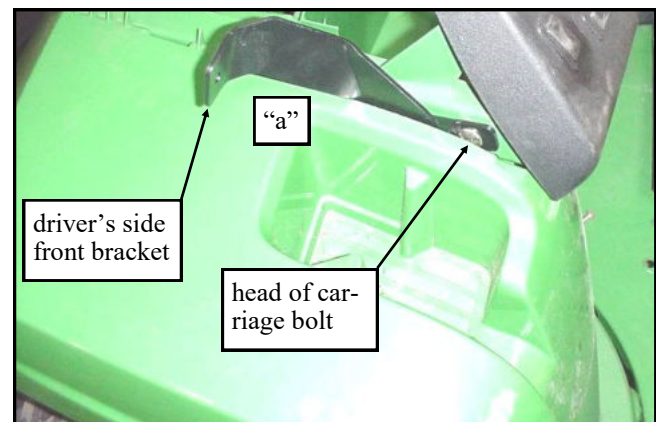

Fig. 4.1
(view from driver's side)

5. REAR MOUNT TABS

5.1 Orient the left and right rear mount tabs so that it lines up with the three hole pattern shown in figure 5.1. Ref.: **ON MODEL TH ONLY**; the angles on the rear mount tab match the underside angles of the plastic fender.

5.2 The rear mount tab should be oriented so that the top mounting surface and top bolt hole is pointing out away from the center of the vehicle. NOTE: the plastic fender shown in fig. 5.1 is only on the TH model. Install rear mount tabs using three (3) 3/8 x 7/8" long hex head bolts, three steel washers, and three locknuts per side. The locknuts go behind the plates without washers. The head of the bolt is outboard as shown with washers under the bolt heads.

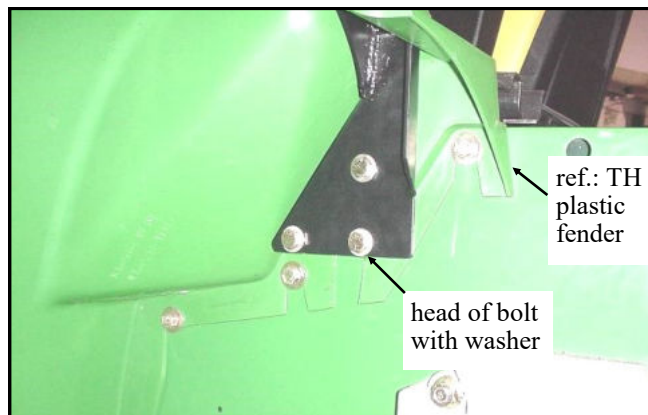

Fig. 5.1
(view from driver's side)

6. FUEL CAP ASSEMBLY

6.1 Remove the cover and loosely position the fuel cap assembly as shown in figure 6.1. NOTE: if your vehicle is model year 2010 or older with the choke under the seat, call Curtis for p/n: 8SV-JDTS04-B4 and p/n: 8SV-JDTS08-B4 which is the appropriate Fuel Cap version that you will need.

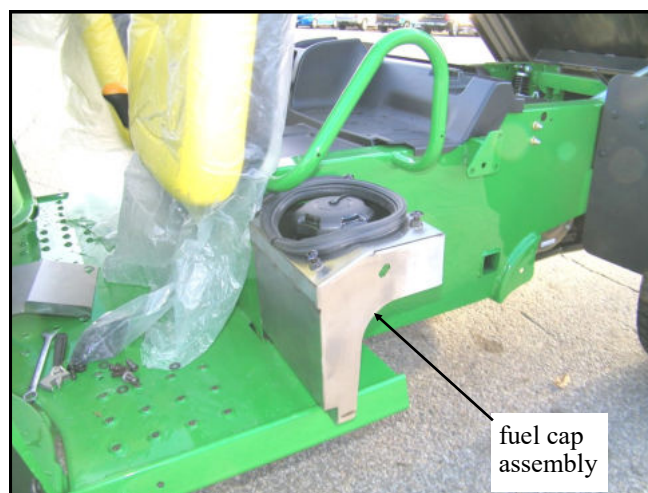

Fig. 6.1
(view from driver's side)

7. SIDE FRAME

7.1 With assistance, remove the doors from the side frames (for easier handling) by unlatching and sliding up and off the hinge pins.

7.2 With assistance, install the left side frame so that the vertical bent lip on the floorboard is in front of the fuel cap assembly. Use care to avoid damaging or distorting the expand-a-foam that seals against the front fender. See figure 7.2.

7.3 The floorboard gets three carriage bolts 5/16 x 1" long, three steel washers, and three locknuts. Washers and locknuts go underneath the vehicle. See fig. 7.2

7.4 Connect the fuel cap assembly to the floorboard using two button head bolts 5/16 x 3/4" long, four steel washers, and two locknuts. Bolt heads to be towards the front of the vehicle as shown in fig. 7.2.

7.5 Connect the fuel cap assembly to the side frame tube with one button head bolt 5/16 x 3/4" long and one steel washer. There is a factory installed threaded insert on the inside surface of the side frame tube in vicinity "b" in fig. 7.2.

7.6 Install right side frame to vehicle floor in the same manner as the left side frame (Step 7.3 above).

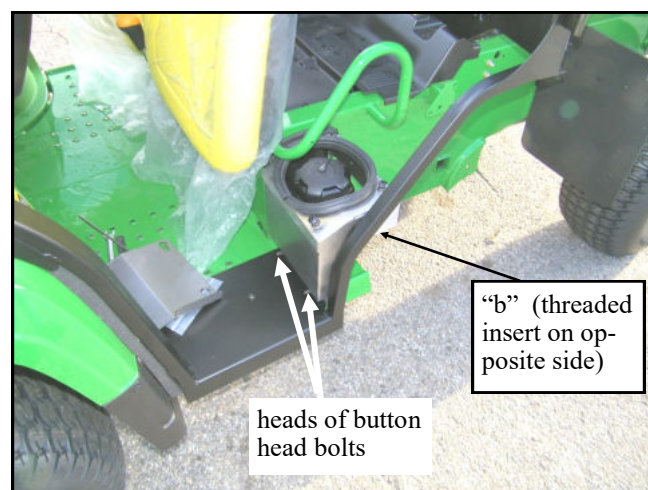

Fig. 7.2
(view from driver's side)

8. LOWER REAR PANEL

8.1 With assistance, install the lower rear panel on top of the rear mount tabs (or on top of the plastic fenders on the TH model only). Orient the lower rear panel so that the bolt holes are facing the back of the vehicle and the foam headliner is facing forwards. See figure 8.1.

8.2 Attach the lower rear panel to the back of the side frames using three button head bolts 5/16 x 3/4" long, three plastic washers, and three steel washers. Reminder: plastic washers have been supplied to provide a weather seal under the heads of all exterior bolts. Note: the back of the side frame has factory installed threaded inserts. See fig. 8.2.

8.3 **MODEL TH ONLY:** drill four 13/32" diameter holes through the plastic fender (two per side). Ref.: see figure 8.1.

8.4 Attach the lower rear panel to the rear mount tabs using a total of four 3/8 x 1" long hex head bolts, eight steel washers, and four locknuts. The heads of the bolts are to be up top and the locknuts underneath. See figure 8.1.

9. AIR INTAKE COVER

9.1 Install the air intake cover as shown in fig. 9.1 so that the two bolt holes on the left line up with the two bolt holes in the rear bent lip of the floorboard. The air intake cover gets bolted behind the stock thickness of the floorboard. Use two button head bolts 5/16 x 3/4" long, four steel washers, and two locknuts. Bolt heads to be towards the front of the vehicle.

9.2 Connect the air intake cover to the passenger's side frame tube with one button head bolt 5/16 x 3/4" long and one steel washer. There is a factory installed threaded insert on the inside surface of the side frame tube in vicinity "c" in fig. 9.1. NOTE: do not install the #10 self-drilling/self-tapping screw in the floorboard of the vehicle until later on when all bolts have been tightened and there are no further adjustments to be made (ref.: step 22.1).

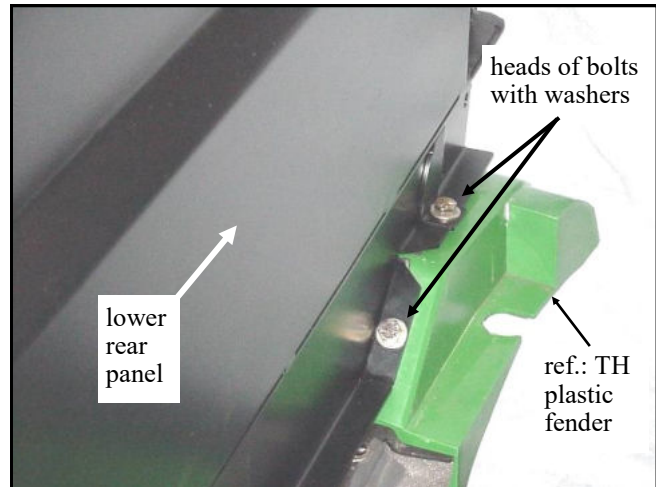

Fig. 8.1
(view from driver's side)

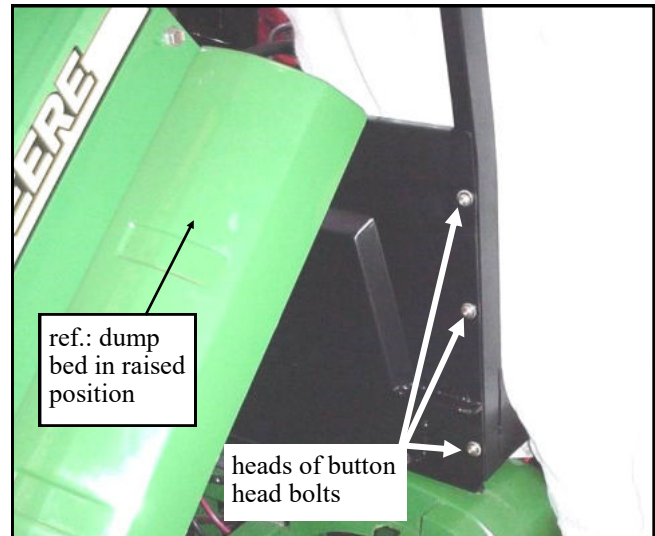

Fig. 8.2
(view from passenger's side)

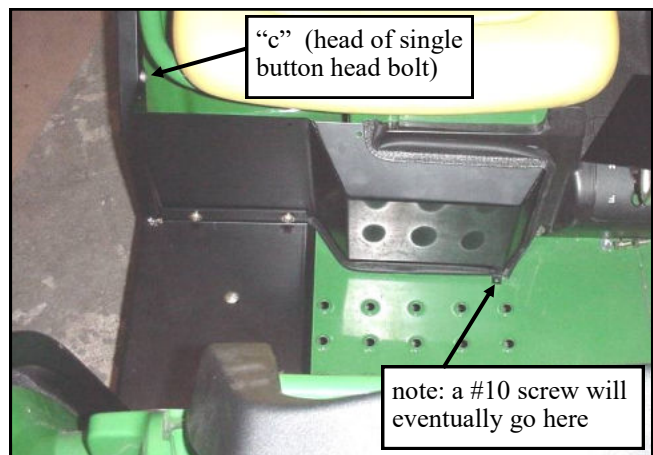

Fig. 9.1
(view from passenger's side)

10. REAR ROOF SUPPORT

10.1 Use a Phillips head screwdriver or other pointed instrument to poke holes through the headliner material. Puncture the headliner from the inside to the outside to avoid having the self-adhesive headliner pull away.

10.2 With assistance, install the rear roof support using a total of four button head bolts $5/16 \times 3/4$ " long, four plastic washers, eight steel washers, and four locknuts. The bolt heads are to be outside the vehicle. See figure 10.2. Note: there will be a top bolt hole on each side that will not get hardware until the roof is installed in step 14.

11. WINDSHIELD SUPPORT

11.1 With assistance, install the windshield support using a total of four button head bolts $5/16 \times 3/4$ " long, four plastic washers, six steel washers, and two locknuts. Two of the four bolts go into factory installed threaded inserts in the side frame as shown in fig. 11.1. All four bolt heads to be facing towards the front of the vehicle. Note: there will be a top hole on each side that will not get hardware until the roof is installed on the next page (step 14).

12. COWL

12.1 Install the cowl to the side frames as shown in figure 12.1. Make sure the bulb rubber is laying forward towards the front of the vehicle as shown. The two outboard bolts go into factory installed threaded inserts in the side frames. Use two $5/16 \times 3/4$ " long button head bolts, two plastic washers, and two steel washers per side.

12.2 Connect the cowl to the front brackets using one button head bolt $5/16 \times 3/4$ " long, one plastic washer, two steel washers, and one locknut per side. Bolt heads to be facing towards the front of the vehicle. Note: a screwdriver or similar device may be used to assist in lining up these last two holes with their respective holes in the front brackets. See fig. 12.1.

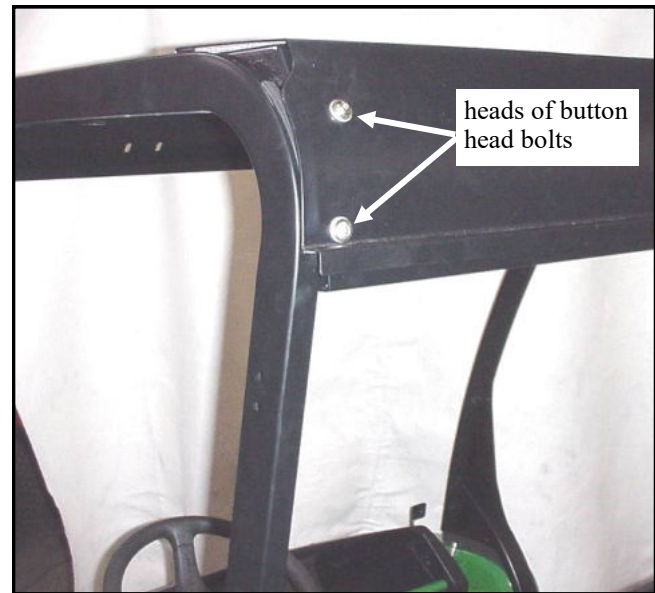

Fig. 10.1
(view from driver's side)

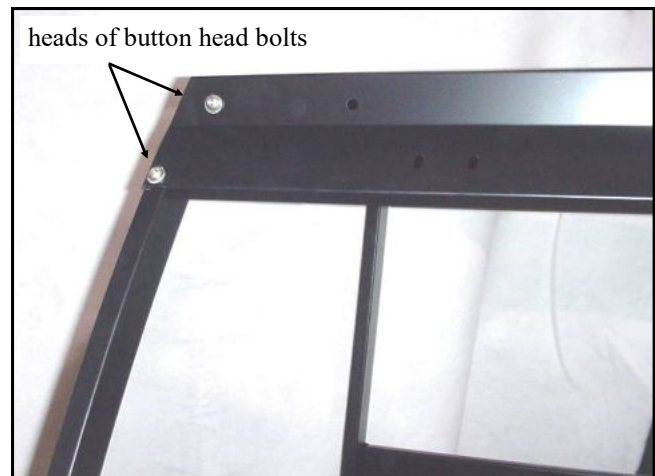

Fig. 11.1
(view from driver's side)

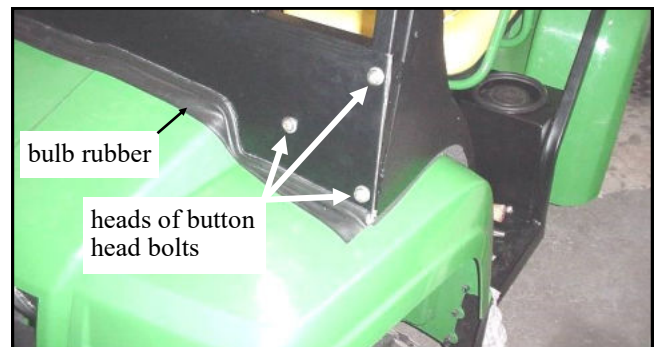

Fig. 12.1
(view from driver's side)

13. WINDSHIELD

13.1 Install 3/4" thick plastic spacers from hardware box on to windshield hinges and insert four flat head bolts. See figure 13.1.

13.2 With assistance, lift the windshield in place and install four steel washers and four locknuts. See figure 13.2.

13.3 Attach windshield latches to windshield latch receivers on the cowl by squeezing tabs to retract spring-loaded pins. See fig. 13.3. Lift up on bottom of windshield while closing latches. Check alignment of windshield with vertical side tubing and tighten hinge hardware. **Note: hinges are plastic components. Do not overtighten. Torque to 7 ft./lbs. max..**

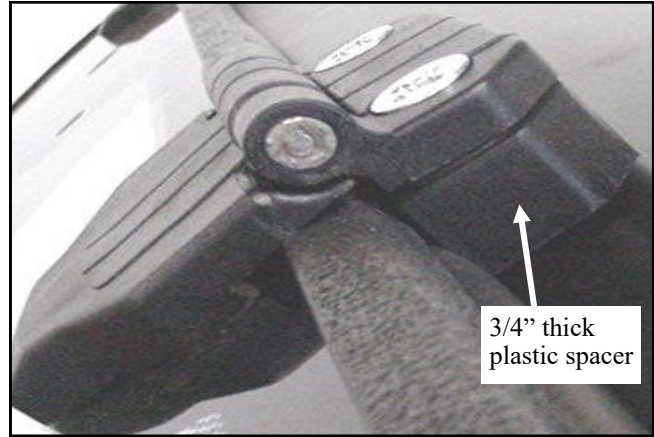

Fig. 13.1
(view from driver's side)

14. ROOF

14.1 Use a Phillips head screwdriver or other pointed instrument to poke holes through the headliner material. Puncture the headliner from the inside to the outside to avoid having the self-adhesive headliner pull away.

14.2 With assistance, install the roof so that the visor portion is facing forwards. Ref.: the visor portion has two holes for optional work lights. Two different length bolts will be used on the roof. The four corners will take four button head bolts 5/16 x 1" long, four plastic washers, eight steel washers, and four locknuts. The remaining five holes will get five button head bolts 5/16 x 3/4" long, five plastic washers, ten steel washers, and five locknuts. All nine locknuts to be on the inside of the cab.



Fig. 13.2
(view from driver's side)

15. TIGHTEN ALL BOLTS

15.1 Re-install all original equipment sheet metal screws from underneath the front fenders, etc.. Note: install the **one** vertically oriented sheet metal screw first. Use a Phillips head screwdriver or other pointed instrument to line up this particular hole as good as possible and install the screw at a slight angle. Next, install all the horizontally oriented sheet metal screws. Tighten all bolts at this time (i.e.: sheet metal screws, carriage bolts, button head bolts, and hex head bolts). Reminder: re-install the two glove box screws also.

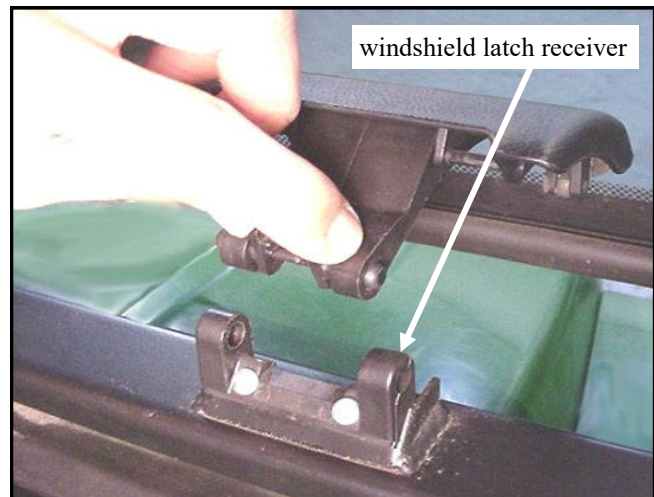

Fig. 13.3
(view from inside cab)

16. DOORS

16.1 Apply lubricant (preferably grease) to the pins mounted on the side frames. With assistance, install the doors onto the pin hinges by guiding both hinge sleeves onto their respective pin hinges. Work the doors back and forth until the hinges are completely seated. Note: the hinges, inside latch, and striker pin can be adjusted for proper engagement. The rotary latch should be adjusted to get two (2) “clicks” when latching.

16.2 **HARD SIDED DOORS ONLY:** install the gas shocks to the side frames and doors with the small piston end towards the door. Press the button on the compression fasteners to lock the gas shock to the ball stud. See figure 16.2.

16.3 **SOFT SIDED DOORS ONLY:** install the wire cable stops to the side frames and doors using two 5/16 x 3/4” long hex head bolts, two steel washers, and two locknuts per side. Leave locknuts loose enough that cable ends can still rotate when door is opened and closed. See fig. 16.3. **Warning: do not attempt to install gas shocks on soft sided doors. Damage to the door will result.**

CAUTION: for safe operation, do not drive with doors open. Make sure doors are closed and properly latched when driving.

17. VINYL FILLERS

17.1 Install the smaller of the two vinyl fillers on the driver’s side. Attach the three snaps to the factory installed stud snaps on the rear of the fuel cap assembly. See figures 17.1 and 17.1a. Lay it out for best fit then apply the adhesive-backed hook velcro where necessary (i.e.: rear panel, inside surface of side frame tubing, etc.). Note: self-adhesive backed velcro should be applied to a clean, dry surface at room temperature.

17.2 Install the larger of the two vinyl fillers on the passenger’s side. Attach the five snaps to the factory installed stud snaps on the air intake cover. See figures 17.1 and 17.2. Lay it out for best fit then apply the adhesive-backed hook velcro where necessary (i.e.: rear panel, inside surface of side frame tubing, etc.).

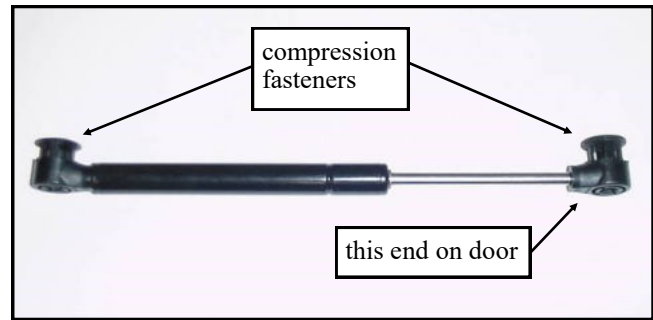

Fig. 16.2 (gas shock for hard sided doors only)



Fig. 16.3 (wire cable stop for soft sided doors)

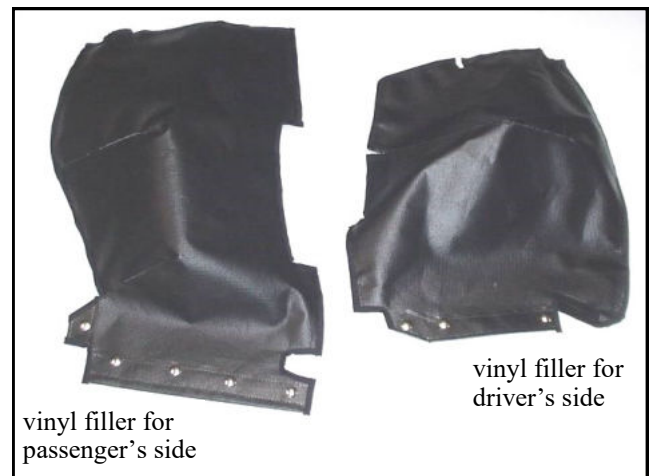

Fig. 17.1 (vinyl fillers)

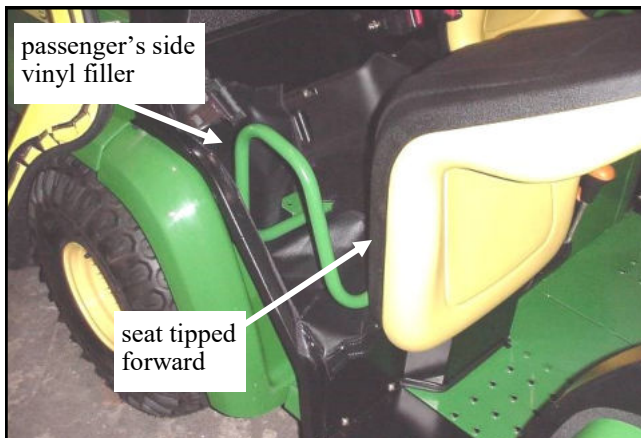

Fig. 17.2 (view from passenger's side)

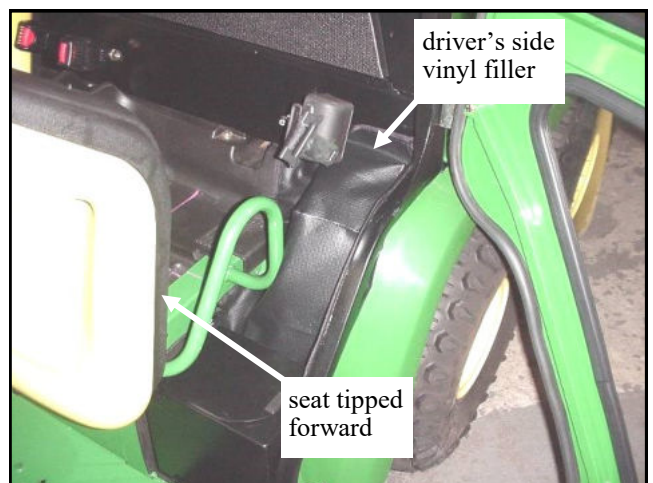

Fig. 17.1a
(view from driver's side)

18. HARD REAR WINDOW

18.1 **HARD SIDED CABS ONLY:** with assistance, install the hard rear panel by fitting it up into the receiving channel of the rear roof support. Make sure the window is centered left to right. NOTE: window is tapered by 1 1/4". The narrow edge goes up top (ref.: this should also be the side with the seam in the factory installed bulb rubber).

18.2 Install the five (5) metal window clips along the bottom of the hard rear window using five #10-32 x 1/2" long pan head Phillips head bolts, five steel washers, and five locknuts. Locknuts and washers to be on the inside of the cab. See fig. 18.2.

18.3 Position one of the two (2) metal right angle window clips on the middle vertical edge of the hard rear window. Make sure the clip is compressing the bulb rubber enough for a good seal from top to bottom. Using a drill, secure the clip to the outside surface of the side frame tubing with one of the #10 x 1/2" long self-drilling/self-tapping screws provided. See figure 18.3. Repeat for opposite side.

19. SOFT REAR CURTAIN (WINDOW)

19.1 **SOFT SIDED CABS ONLY:** Install the supplied adhesive-backed hook velcro to the back side of the side frame tubing on the left and right sides of the cab. Note: adhesive-backed velcro should be applied to a clean, dry surface at room temperature.

19.2 Attach the soft rear curtain (window) to the upper and lower factory installed stud snaps and the newly installed velcro on the back side of the vehicle.

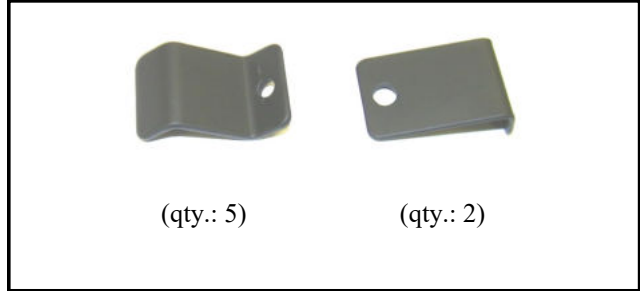

Fig. 18.2
(both metal window
clip styles shown)



Fig. 18.3
(metal window clips)
(view from driver's side)

20. SEAT BELTS

20.1 Install each seat belt receiver to the center of the lower rear panel using one 7/16-20 x 1" long hex head bolts, one steel washer, and one locknut. See fig. 20.1.

20.2 Install one seat belt retractor to the left and right sides of the lower rear panel using one 7/16-20 x 1" long hex head bolt, one steel washer, and one locknut. Figure 20.2 shows the driver's side seat belt retractor.

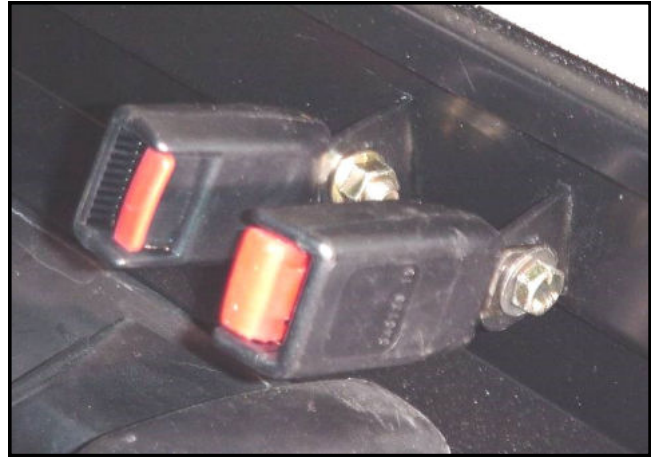

Fig. 20.1 (seat belt receivers)

21. FINISHING TOUCHES

21.1 Press the air intake cover tight against the under seat area to create a seal then, using a drill, install a #10 x 1/2" long self-drilling/self-tapping screw in the tab of the air intake cover to secure it to the floorboard of the vehicle. See fig. 21.1. Ref.: step 9 is where the air intake cover was partially installed and to be completed here.

21.2 Install the fuel cap lid by inserting the slots over the bolt heads on the top of the fuel cap assembly. Slide toward the passenger side of the vehicle to latch in place. Note that if more clearance is needed for the hip restraint or fuel tank cap the height of the three bolts can be adjusted.

21.3 Install all supplied nut covers on the locknuts that are inside the cab. Install a 5/16" nut cover on the locknut of the ball stud on each door.

21.4 **MODEL TH ONLY:** re-install the middle wheel on each side of the vehicle (previously removed in step 1).



Fig. 20.2 (seat belt retractors)

22. WINDSHIELD WIPER

22.1 Install per instructions included in wiper kit.

23. CARE AND MAINTENANCE

23.1 Check and tighten hardware after 40 hours of operation. Periodically inspect and tighten hardware for the remainder of the unit's life.

23.2 Wash the painted surfaces of the unit with commercial automotive cleaning products.

23.3 Clean windows with glass cleaner.

23.4 Vinyl components should be washed with a mild solution of warm soapy water.

23.5 Clear vinyl can be easily scratched. Be careful cleaning frost or snow from windows. Do not roll curtains in cold weather. The windows become stiff and may crack. Keep windows clean.

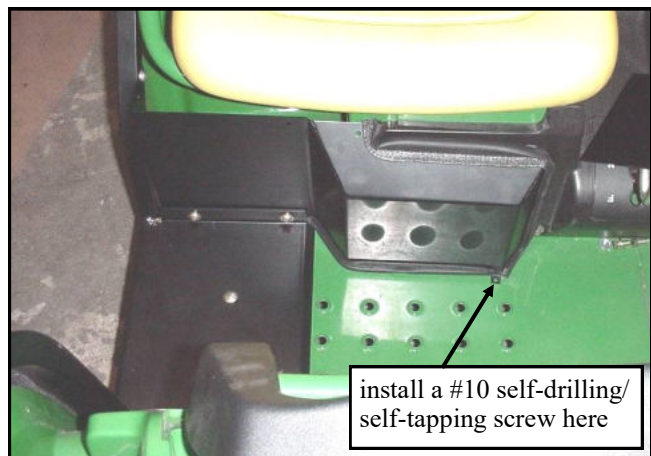
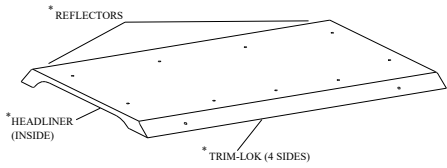

Fig. 21.1
(view from passenger's side)

J.D. GATOR TS, TX, TE, and TH HARD SIDED CAB PARTS LIST (p/n 1GTS1AS)

ROOF QTY. P/N
1 8SV-JDTS01-G4 (GREEN)



WINDSHIELD QTY. P/N
1 8SV-JDTS02

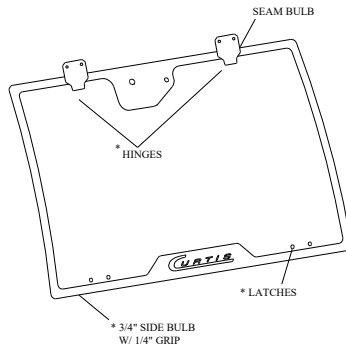

LOWER REAR PANEL ASSEMBLY QTY. P/N
1 8SV-JDTS05-B4

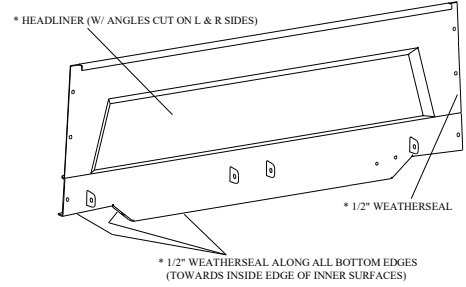

AIR INTAKE COVER QTY. P/N
1 8SV-JDTS03-B4

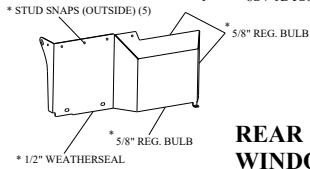

REAR WINDOW QTY. P/N
1 8SV-JDTSAS06

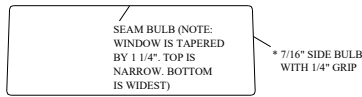

VINYL FILLERS QTY. P/N
LEFT 1 8SV-JDTS15L-VC
RIGHT 1 8SV-JDTS15R-VC



COWL QTY. P/N
1 8SV-JDTS10-B4

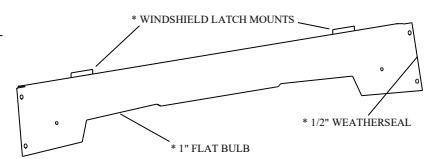

FUEL CAP LID QTY. P/N
1 8SV-JDTS04B-B4

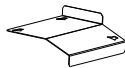

FUEL CAP ASSEMBLY QTY. P/N
1 8SV-JDTS08B-B4

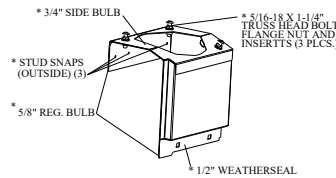

WINDSHIELD SUPPORT QTY. P/N
1 8SV-JDTS13-B4

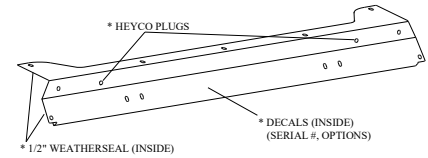

REAR MOUNT TAB ASS'Y. QTY. P/N
LEFT 1 8SV-JDTS11L-B4
RIGHT 1 8SV-JDTS11R-B4

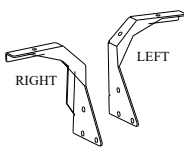

FRONT BRACKETS QTY. P/N
LEFT 1 8SV-JDTS12L-B4
RIGHT 1 8SV-JDTS12R-B4

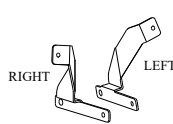

REAR ROOF SUPPORT ASS'Y. QTY. P/N
1 8SV-JDTS14-B4

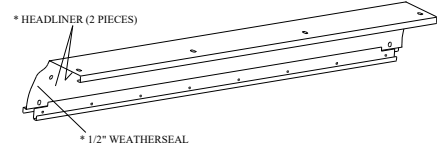

RUBBER TYPES:

| | | | | | | | |
|-------------------------|----------------------------------|---|-------------------------------|--|-----------------------------|---|-------------------------------|
| TRIM-LOK 9SV-PR01-10 | 1/2" WEATHER SEAL 9SV-PR20-10 | 7/16" SIDE BULB W/ 1/4" GRIP 9SV-PR29-15 | 3/4" SIDE BULB 9SV-PR17-20 | 3/4" SIDE BULB W/ 1/4" GRIP 9SV-PR20-15 | 1" FLAT BULB 9SV-PR05-10 | 1/4" x 3/4" EXPAND-A-FOAM 9SV-PR30-5 | 5/8" REG. BULB 9SV-PR02-15 |
|-------------------------|----------------------------------|---|-------------------------------|--|-----------------------------|---|-------------------------------|

UNITIZED SIDE FRAMES HARD CAB QTY. P/N
LEFT 1 8SV-JDTAS9L-B4
RIGHT 1 8SV-JDTAS9R-B4

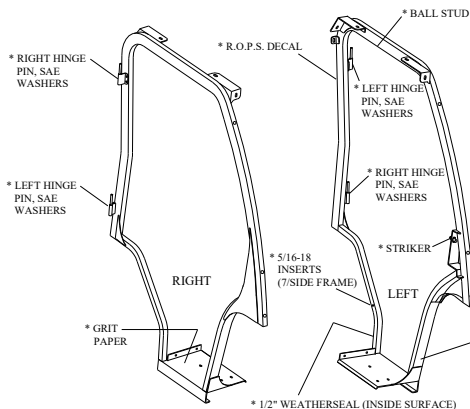

HARD DOORS QTY. P/N
LEFT 1 8SV-JDTAS7L-B4 (BLACK)
LEFT 1 8SV-JDTAS7L-G4 (GREEN)
RIGHT 1 8SV-JDTAS7R-B4 (BLACK)
RIGHT 1 8SV-JDTAS7R-G4 (GREEN)

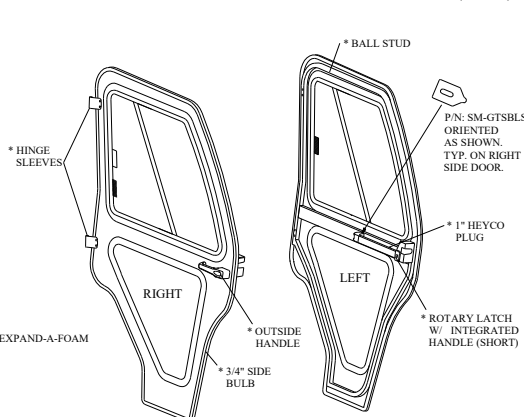

*IN HOUSE APPLICATIONS

ADDITIONAL SERVICE PARTS

| P/N | DESCRIPTION |
|------------|---------------------------------------|
| 9SV-HWS | WINDSHIELD HINGE KIT |
| 9SV-WL1 | WINDSHIELD LATCH KIT 1 |
| 9SV-HDR1 | DOOR HINGE KIT 1 |
| 8SV-SWGR1 | LEFT DOOR SLIDER ASSEMBLY |
| 8SV-SWGR3R | RIGHT DOOR SLIDER ASSEMBLY |
| 9SV-DL03 | DOOR LATCH NON-LOCKING W/ GRAB HANDLE |
| 9SV-OHRL | OUTSIDE HANDLE ROTARY LATCH KIT |
| 9SV-GS02 | GAS SPRING (12") |
| JDH-12 | SEAT BELT KIT (W/O HARDWARE) |
| JDTSHWK-01 | HARDWARE KIT |
| JDTSHWK-02 | REAR PANEL HARDWARE KIT |
| 9PC01 | FUEL CAP LID LATCH |
| 8SV-PGTSLD | LOWER DOOR ACRYLIC WINDOW |

CABS/BLADES/SPREADERS/ACCESSORIES

J.D. GATOR TS, TX, TE, and TH SOFT SIDED CAB PARTS LIST (p/n 1GTS1SS)

ROOF QTY. P/N

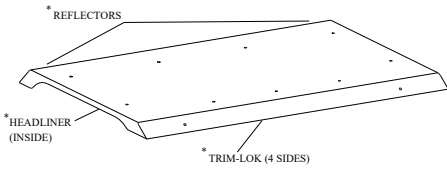

WINDSHIELD QTY. P/N

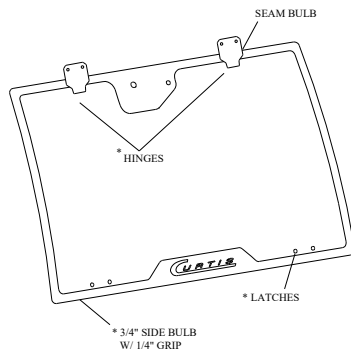

LOWER REAR PANEL ASSEMBLY QTY. P/N

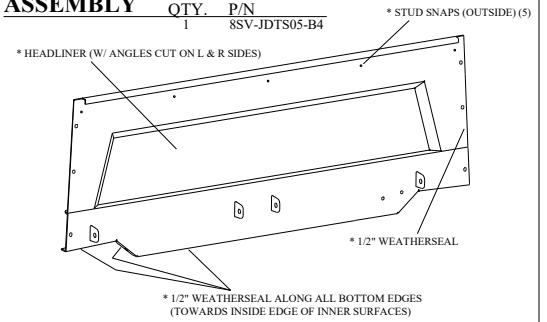

AIR INTAKE COVER QTY. P/N

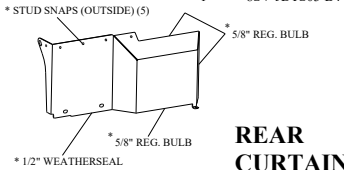

REAR CURTAIN QTY. P/N

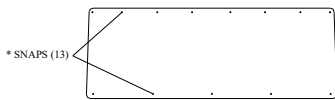

VINYL FILLERS QTY. P/N

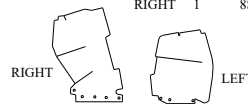

COWL QTY. P/N

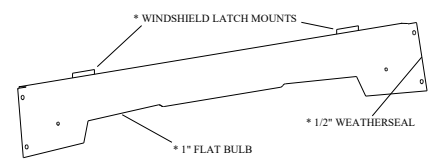

FUEL CAP LID QTY. P/N

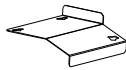

FUEL CAP ASSEMBLY QTY. P/N

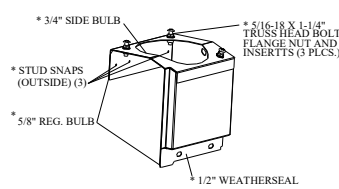

WINDSHIELD SUPPORT QTY. P/N

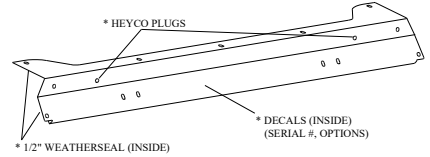

REAR MOUNT TAB ASS'Y. QTY. P/N

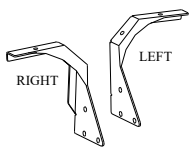

FRONT BRACKETS QTY. P/N

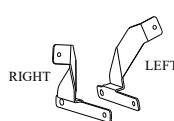

REAR ROOF SUPPORT ASS'Y. QTY. P/N

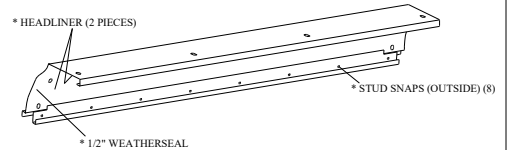

RUBBER TYPES:

| | | | | | | | |
|-------------------------|----------------------------------|------------------------------|--|--|-----------------------------|---|-------------------------------|
| TRIM-LOK 95V-PRO1-10 | 1/2" WEATHER SEAL 95V-PR20-10 | 3/4" SIDE BULB 95V-PR17-5 | 5/8" SIDE BULB W/ 1/4" GRIP 95V-PR23-45 | 3/4" SIDE BULB W/ 1/4" GRIP 95V-PR20-45 | 1" FLAT BULB 95V-PRO5-10 | 1 1/4" x 3/4" EXPAND-A-FOAM 95V-PR30-5 | 5/8" REG. BULB 95V-PRO2-15 |
|-------------------------|----------------------------------|------------------------------|--|--|-----------------------------|---|-------------------------------|

UNITIZED SIDE FRAMES SOFT CAB QTY. P/N

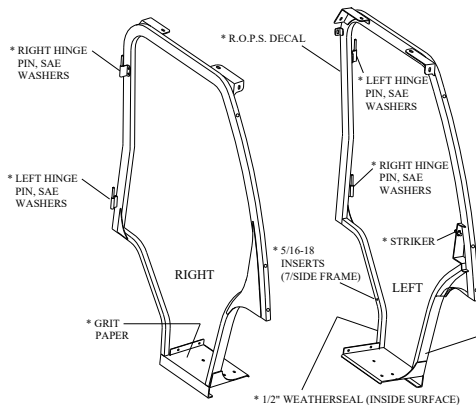

SOFT DOORS QTY. P/N

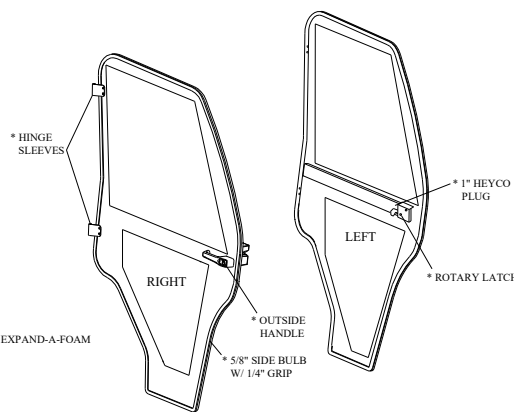

ADDITIONAL SERVICE PARTS

| P/N | DESCRIPTION |
|------------|---------------------------------|
| 95V-IHRL | INSIDE HANDLE ROTARY LATCH KIT |
| 95V-OHRL | OUTSIDE HANDLE ROTARY LATCH KIT |
| 95V-DS02 | DOOR STOP |
| JDTSHWK-01 | HARDWARE KIT |
| JDH-12 | SEAT BELT KIT (W/O HARDWARE) |
| 9PC01 | FUEL CAP LID LATCH |

*IN HOUSE APPLICATIONS

CABS/BLADES/SPREADERS/ACCESSORIES