



Ferris ISX 3300
(p/n: 1FISX33PR)
 Cab with A/C
 Fits 36HP and 40HP Briggs & Stratton Vanguard
 Big Block engines
 Fits 60", 61", and 72" side discharge mowers
 (Does not fit with bagger systems)

While this cab kit was designed to fit on the vehicle listed above, manufacturing tolerances and vehicle assembly may affect cab fitment. It is the responsibility of the cab installer to check all vehicle pedals and levers for full functionality and, as required, adjust the cab fitment to prevent any interference of the cab components with the travel of pedals or levers.



Premium Cab Shown with Options

Available Options:

1. Side View Mirrors (P/N: 9PM5)
2. Switch Panel (P/N: 1FISX33CK) (required for the following 2 items)
3. Front LED Work Lights (P/N: 1ZTRLK)
4. Front Wiper/Washer Kit (P/N: 1ZTRWK)

Approximate Installation Time *
Experienced Dealer Technician – 4 Hours
Average Dealer Technician – 6 Hours
Do-It-Yourself – 6-8 Hours

Approximate Product Specifications
Floorboard to Roof Height: 57 inches
Weight: 252 lbs.
Cab Width: 50 inches

(*=Not including accessories)

Register your new product quickly online at Curtiscab.com/product-registration/



Curtis encourages all customers to register their Curtis products. However, failure to do so will not diminish right to warranty. Curtis Industries does not sell or share your information with anyone else.

Download a digital copy of your installation instructions online at Curtiscab.com/literature/



Curtis strives to continuously improve our products, technical documentation, etc. Therefore, the installation manual for this product may have been updated after your product was packaged. The latest revision of the installation manual can always be found at the website above.

The contents of this envelope are the property of the owner. Leave with the owner when installation is complete.

TABLE OF CONTENTS

WARNINGS, TIPS, & REQUIRED TOOLS.....	3
VEHICLE PREP.....	4-6
CAB INSTALLATION.....	7-16
CAB FEATURES & OPERATION.....	17
CARE AND MAINTENANCE.....	18
TROUBLESHOOTING.....	18
WIRING SCHEMATIC.....	19
SERVICE PARTS	20-26
BOLT TORQUE SPECIFICATIONS	27





WARNINGS, TIPS, & REQUIRED TOOLS

Curtis cabs feature an assembly of parts designed for your vehicle which require adjustment and alignment of components to accommodate vehicle variations and provide proper weather protection. For accurate installation, proper operation, and years of satisfaction, please read and understand the installation and owner's manual fully prior to installing the cab.

From all of us at Curtis, we thank you for choosing our product.

	NOTICE
<p>Curtis Cabs, blades and general accessories add additional weight to the base vehicle. All Curtis accessory weights are listed in product brochures. Deduct the accessory's total weight from the vehicle's rated capacity and never exceed the vehicle's rated capacity including driver and passenger.</p>	

	<p>WARNING Exposure to Carbon Monoxide can Cause illness, serious injury or death. Never operate vehicle if suspicious of Carbon Monoxide. Inspect exhaust system for leaks monthly. Leaks can result from loose connections, corrosion, cracks or other damage to the exhaust manifold. If leaks are found, repair or replace exhaust system. Do not use vehicle until repair or replacement is complete.</p>
---	---

	
WARNING	
Serious Injury or Death	
	This cab enclosure does not provide protection from rollover or other accidents.
	This cab enclosure does not provide protection from flying objects including golf balls.
	This cab enclosure does not provide protection from lightning. When lightning threatens take cover and do not operate vehicle.

California Health and Safety Proposition 65 Warning: This product may contain chemicals known to the state of California to cause cancer and birth defects or other reproductive harm.

GENERAL INFORMATION BEFORE YOU START

HELPFUL HINTS:

- Refer to parts diagram found in the service parts section of this manual to help identify parts during the assembly process.
- To assist with the cab installation, leave all fasteners loose for later adjustment unless otherwise specified.
- Read and understand all instructions before beginning.
- Apply a silicone sealant to seal any minor gaps that may occur due to vehicle variations.
- Use caution to avoid damaging the factory installed threaded inserts or weld nuts. Begin the thread engagement by hand to avoid or correct potential cross threading.
- Make sure the areas where the supplied self-adhesive hook Velcro will be applied are clean and dry and at room temperature for best adhesion.

TOOLS REQUIRED:

- | | |
|---|---|
| <ul style="list-style-type: none"> • Set of Standard and Metric Sockets (3/8" + 1/2" Drive) • 3/8" + 1/2" Drive Ratchets and Long Drive Extension • Set of Standard and Metric Open-End Wrenches • Set of Standard and Metric Allen Wrenches • #1, #2, and #3 Phillips Head Screwdrivers • Torque Wrench (1/2" Drive) • Rubber Mallet or Plastic Dead Blow Hammer • Bungee Cord or Twine • Hoisting Strap • 1-1/2" Hole Saw • T25 and T30 Torx Wrench or Driver • Cut-Off Wheel | <ul style="list-style-type: none"> • Drill/Driver • 9/32" Drill Bit • #2 and #3 Phillips Head Bit • Utility Knife • Pair of Scissors • Shears • Grease • Black Silicone Sealant • Steel Straight Edge • Wire Cutter or Snips • Belt Tension Tester |
|---|---|

CAB INSTALLATION

Step 1: (Vehicle Engine Prep)

- 1.1 Park vehicle in a location accessible by an overhead hoist.
- 1.2 Disconnect the negative battery terminal.

Tools Required

7/16" wrench or socket

- 1.3 See fig. 1.3. Remove the upper wire screen and lower mesh screen from the top of the vehicle's engine. Discard the upper screen, but retain the lower mesh screen, triangle, and hardware.

Tools Required

10mm wrench or socket

T30 Torx wrench or driver

- 1.4 See fig. 1.4. Install stub shaft onto the top of the engine crankshaft with three 8mm socket head cap bolts and split lock washers and tighten hardware to 20 ft-lbs. (27.2 N-m)..

Tools Required

6mm Allen hex wrench or driver

Hardware Used

<u>Hardware Used</u>	<u>Qty</u>
M8x1.25 x 25mm Socket Cap Bolt	3
M8 Split Lock Washer	3

- 1.5 See fig. 1.5. Take the metal drill template and hardware from the small polybag from the small hardware box. Attach the template to the underside of the mesh screen using the hardware from the polybag.

Use a 1-1/2" hole saw, with the center pilot drill removed, to cut a hole in the mesh screen through the center hole in the drill template. A small rotary cutter, wire cutters or similar tools may also be used, using the template to ensure the size and centricity of the hole. The hole in the mesh screen should fit closely over the new stub shaft. The screen will rotate with the shaft, so a tight fit is permissible, however the hole can be trimmed further if desired. Remove and discard the template and hardware.

Tools Required

3/8" and 7/16" hex wrenches or sockets

1-1/2" hole saw or other cutter

Hardware Used

<u>Hardware Used</u>	<u>Qty</u>
1/4-20 x 5/8" Flanged Hex Bolt	3
1/4-20 Flanged Lock Nut	3

- 1.6 See fig. 1.6. Re-install the triangle and mesh screen onto the engine using its original hardware. Tighten all hardware. Save the remaining hardware removed in step 1.3 for use later.

Tools Required

T30 Torx wrench or driver

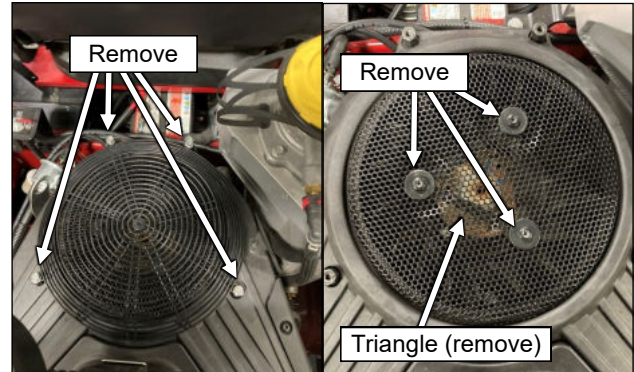

Fig. 1.3 (Remove engine screens)

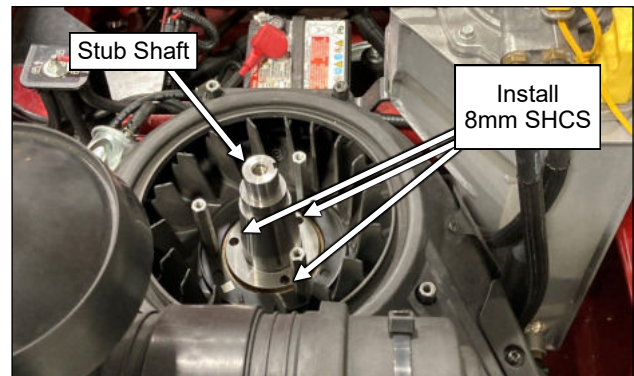

Fig. 1.4 (Install stub shaft)

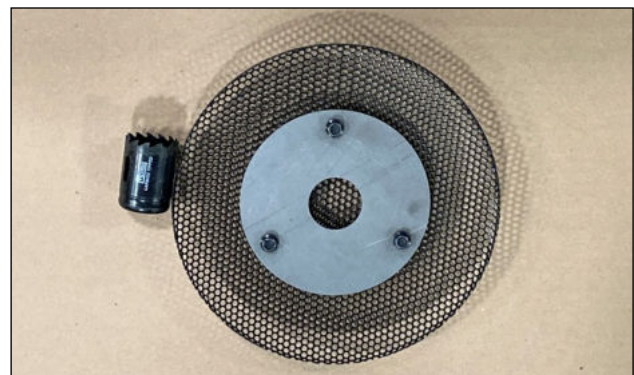

Fig. 1.5 (Cut hole in mesh screen)

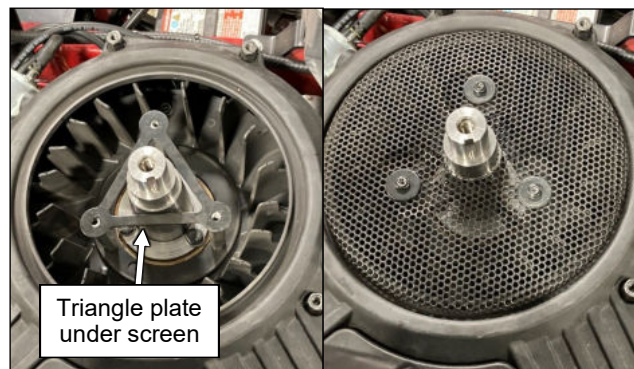

Fig. 1.6 (Re-install screen)

CAB INSTALLATION

Step 1: (Vehicle Engine Prep, continued)

- 1.7 See fig. 1.7. Loosen the set screw on the pulley from the hardware box until it does not protrude into the slot. Place the machine key from the hardware kit into the slot in the stub shaft and slide the pulley over the shaft aligned to the key, then tighten the set screw. Secure the pulley with the large washer from the larger polybag from the hardware box, along with a 7/16" bolt and split lock washer. Torque the 7/16" bolt to 32 ft-lbs. (43.4 N-m).

Tools Required

5/32" Allen hex wrench or driver

5/8" hex wrench or socket

Hardware Used

	<u>Qty</u>
1/4" Square x 3/4" Ig. Machine Key	1
7/16-20 x 1.75" Hex Head Bolt	3
7/16" Split Lock Washer	3
1.625" OD x 3/8" thick Washer	1

Step 2: (Vehicle Interior Prep)

- 2.1 Press the small lever at the rear-left base of the seat and rotate the seat forward.

(for floorboard replacement on model years 2025+, see steps 2.1.1-2.1.6 on the next page)

- 2.2 Remove the rear left nut holding the seat to the seat base. Per fig. 2.2, install the seat lever seal panel on the under side of the seat base, aligned to the seat bolt and the small hole in the seat base. Secure the panel with the seat nut and a 1/4" bolt and nut.

Tools Required

3/8", 7/16", and 13mm hex wrenches or sockets

Hardware Used

	<u>Qty</u>
1/4-20 x 5/8" Flanged Hex Bolt	1
1/4-20 Flanged Lock Nut	1

- 2.3 Remove the headrest mount from the seat back, re-install the bolts into the seat back, and tighten snug.

Tools Required

3/16" Allen key or driver

- 2.4 See Fig. 2.4. Remove the headrest from the headrest mount and install the headrest onto the new mount from the larger hardware box. Make sure the bends on the headrest mount face away from the headrest. Re-use the hardware and tighten snug. Set the headrest assembly aside.

- 2.5 Remove the floor pan from the vehicle. Take the 5' length of bulb rubber from the hardware box. See fig. 2.5. Trim one end of the rubber at a 45° angle and place it at the rear corner of the floor pan and trim at the front end with about an inch excess.

Repeat for the next piece with an opposite angle along the back edge of the floor pan and push the two rubber corners together. Trim the remaining rubber to the other rear corner leaving no gaps in the rubber, then trim the rubber flush to the front edge of the floor pan.

- 2.6 Re-install the floor pan.

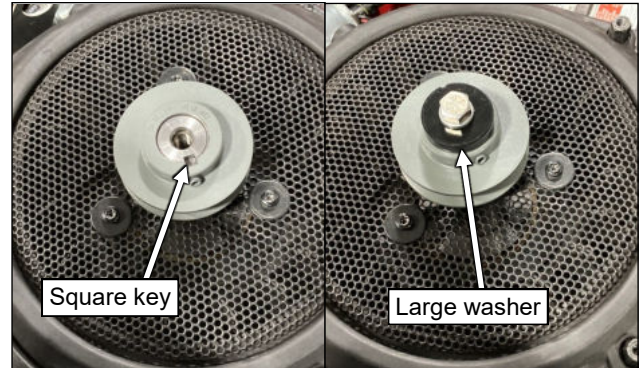

Fig. 1.7 (Install Pulley)

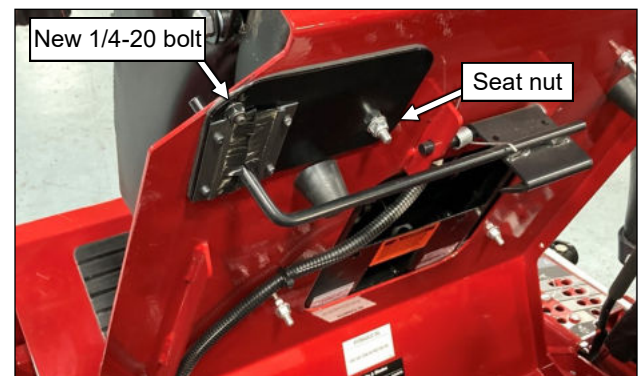

Fig. 2.2 (Install seat lever seal)



Fig. 2.4 (Install headrest to new mount)



Fig. 2.5 (Install rubber to floor pan)

CAB INSTALLATION

Step 2.1: (2025+ Vehicle Floorboard Replacement)

- 2.1.1 Follow steps 2.1 through 2.4 from the **2024 and Older Vehicle Interior Prep** section on the previous page.
- 2.1.2 Remove the perforated floor pan from the vehicle. See fig. 2.1.2. Take the rubber floormat from the hardware box. Install the floormat to the top of the floor pan (rubber facing up) using the following hardware.

Tools Required

1/2" hex wrenches or sockets
5/16" Allen wrench or driver

Hardware Used

	<u>Qty</u>
5/16-18 x 1" Button Head Bolt	4
5/16 x 1.25" Steel Fender Washer	4
5/16 x 1.5" Steel Fender Washer	4
5/16-18 Flanged Lock Nut	4

Place the 5/16 x 1.25" black washers onto the bolts. Insert the bolts through the holes of floormat and into the four outer most corner holes of the perforated floor pan. On the under side of the floor pan, place the larger silver 5/16 x 1.5" washers onto the bolts and secure with the flanged lock nuts. The floormat and floor pan should be sandwiched between both washers. Tighten all bolts.

- 2.1.3 Take the 5' length of bulb rubber from the hardware box. Reference fig. 2.5 on the previous page. Trim one end of the rubber at a 45° angle and place it at the rear corner of the floor pan and trim at the front end with about an inch excess.

Repeat for the next piece with an opposite angle along the back edge of the floor pan and push the two rubber corners together. Trim the remaining rubber to the other rear corner leaving no gaps in the rubber, then trim the rubber flush to the front edge of the floor pan. Place to the side.

Tools Required

Shears

- 2.1.4 See fig. 2.1.4. Remove the perforated floorboard from the vehicle. Remove both vibration rubber stoppers from the old floorboard and install them on to the new floorboard found in the hardware box.
- 2.1.5 Install the new floorboard with the hardware previously removed.
- 2.1.6 Re-install the floor pan.

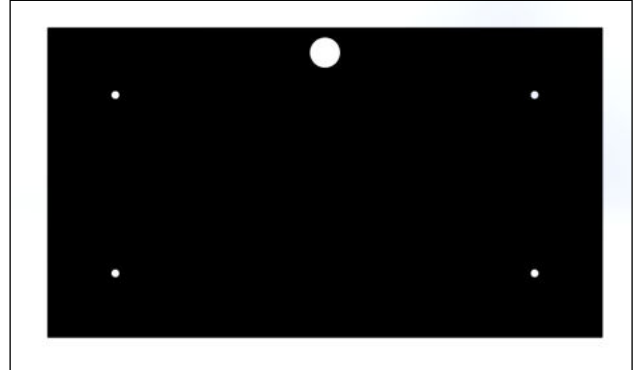

Fig. 2.1.2 (Rubber Floormat)

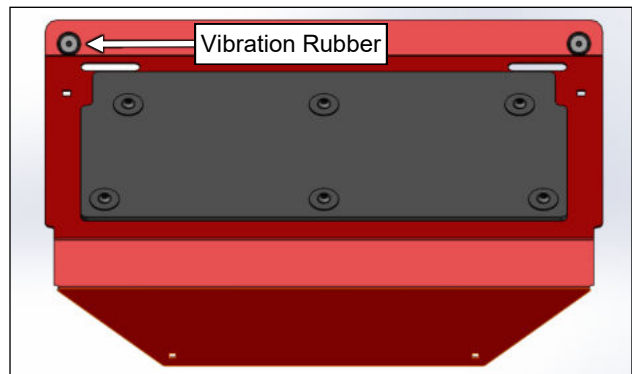

Fig. 2.1.4 (New Floorboard)

CAB INSTALLATION

Step 3: (Install Cab Mounts)

CAUTION: Work on the following steps one side at a time so that the opposite side will remain fastened.

- 3.1 See fig. 3.1. Remove the 1/2" bolt and nut from the bottom of the right side of the vehicle ROPS. Install the right side ROPS mount with the 1/2" bolt through the bracket and the ROPS. Install the nut loosely onto the bolt.

Tools Required

3/4" hex wrench or socket

- 3.2 Hook the tab on the ROPS bracket into the mount and secure with two 5/16" bolts and nuts.

Tools Required

1/2" hex wrenches or sockets

Hardware Used

5/16-18 x 1" Flanged Hex Bolt
5/16-18 Flanged Lock Nut

Qty

2
2

- 3.3 See fig. 3.3. Repeat steps 3.1 and 3.2 for the left side ROPS mount and bracket, using the longer 1/2" bolt from the hardware kit. Install the nut loosely onto the bolt at this time. The longer bolt will be used to help secure the A/C compressor bracket.

Tools Required

3/4" hex wrench or socket

1/2" hex wrenches or sockets

Hardware Used

1/2-13 X 3.5" Flanged Hex Bolt
5/16-18 x 1" Flanged Hex Bolt
5/16-18 Flanged Lock Nut

Qty

1
2
2

- 3.4 Note the placement of the bolts at the top of the shock towers on the vehicle:
- If the head of the bolt is on the front side, remove the nut from the bolt and leave the bolt in place.
 - If the bolt head is on the rear side, lift the vehicle to relieve pressure on the bolt, remove the bolt and re-install it on the front side of the shock tower.

Tools Required

9/16" hex wrenches or sockets

- 3.5 See Fig. 3.5. Install the front cab mounts onto the shock tower bolts, on the rear side of the shock towers and re-install the nuts onto the bolts. Align the top surfaces of the mounts parallel to each other and tighten snug. Do not fully torque at this time
- 3.6 Remove the ROPS pin and cotter pin from one side of the vehicle ROPS. Cut the ROPS pin 1/4" to 3/8" from the large shoulder on the pin, discarding the curved section as shown in Fig. 3.6.

Tools Required

Cut-Off Wheel

Re-install the shortened pin into the ROPS and repeat for the other side.

NOTE: the cab will not fit over the ROPS pins if they are not trimmed.

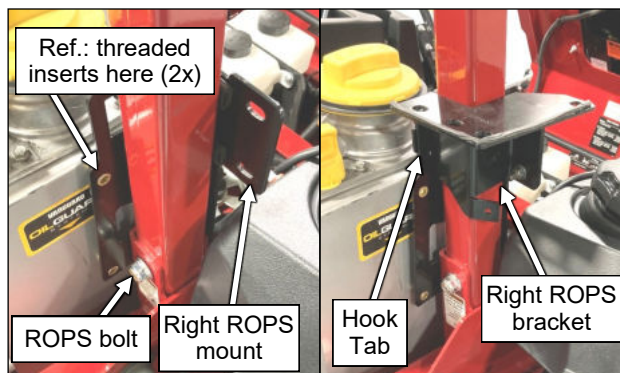

Fig. 3.1 (Install right side ROPS mount)

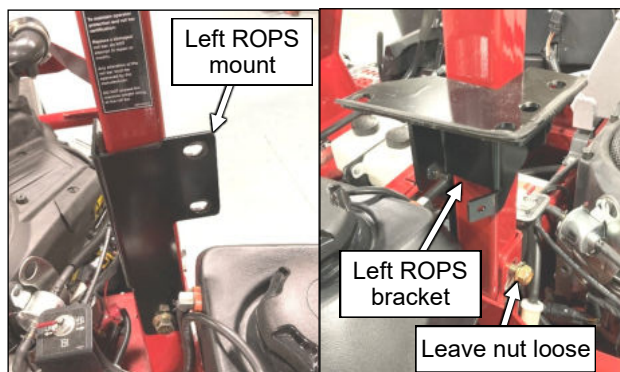

Fig. 3.3 (Install left side ROPS mount)

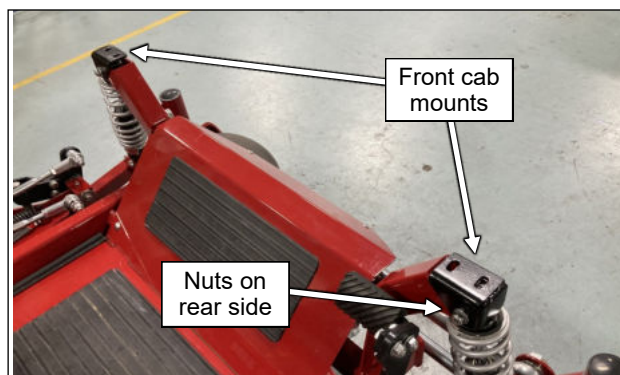

Fig. 3.5 (Install front cab mounts)

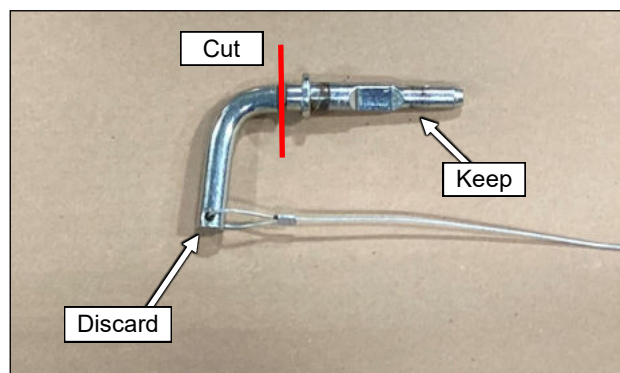

Fig. 3.6 (Trim ROPS pins)

CAB INSTALLATION

Step 4: (Cab Installation)

- 4.1 See fig. 4.1. Set the deck height for the mower to 3-1/2". This will place the height adjustment lever to a near vertical position for minimal interference with the cab as it's lowered.
- 4.2 Remove the doors from the cab and set aside carefully to prevent scratching the panels.
- 4.3 See fig. 4.3. Remove the 3 bolts securing the compressor bracket to the base of the rear shipping mount and cut any zip ties holding the hoses and wire harness to the shipping mount. Support the compressor using a bungee cord or rope. Do not ever use the hoses to support the compressor or damage may occur.

Tools Required

9/16" hex wrenches or sockets

- 4.4 See fig. 4.4. Position a lifting strap where shown so that it sits roughly centered on the hinge tubes and the ball studs on the frames.
- 4.5 See figure 4.5. Put tension on the lifting strap with the overhead hoist. Remove and discard the 8 bolts holding the rear of the cab down to the rear shipping mount as well as the 4 bolts holding the cab to the front mounts.

Tools Required

1/2" hex wrenches or sockets

- 4.6 With assistance, lift the cab and position over the vehicle. Be sure to support the A/C compressor so that it never hangs from the hoses.
- 4.7 Lower the cab slowly onto the vehicle being careful to not scratch the fenders with the rear edge of the floorboard. The ROPS should be entirely inside the cab a few inches in front of the rear of the cab. Make sure the A/C wire harness is not pinched underneath the cab.
- 4.8 See fig. 4.8. Fasten the rear of the cab to the ROPS mounts using the following hardware. Leave loose at this time.

Tools Required

1/2" hex wrenches or sockets

Hardware Used

	<u>Qty</u>
5/16-18 x 1" Flanged Hex Bolt	8
5/16"x1" Steel Fender Washers	12
5/16-18 Flange Lock Nut	4

- 4.9 See fig. 4.8. Fasten the cab to the front mounts of the tractor using the following hardware.

Tools Required

1/2" hex wrenches or sockets

Hardware Used

	<u>Qty</u>
5/16-18 x 1" Flanged Hex Bolt	4
5/16"x1" Steel Fender Washers	4
5/16-18 Flange Lock Nut	4

- 4.10 Check for a complete seal around the perimeter of the cab, then tighten all bolts from steps 4.8 and 4.9 snug. Torque the 3/8-16 front shock tower bolts to 20 ft-lbs. (27.2 N-m).



Fig. 4.1 (Set mower deck height to 3-1/2")

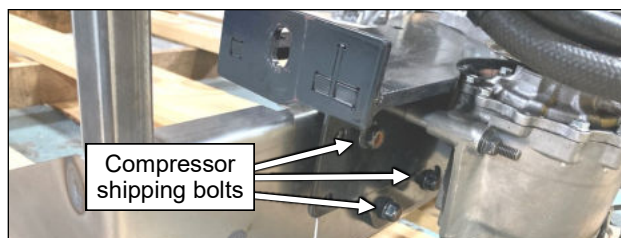

Fig. 4.3 (Unbolt Compressor)

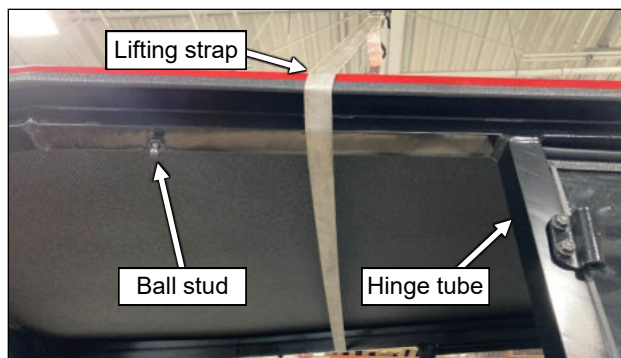

Fig. 4.4 (Position lifting strap)

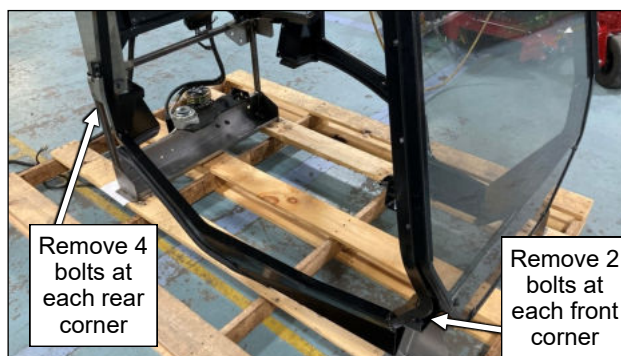

Fig. 4.5 (Cab pallet bolts)

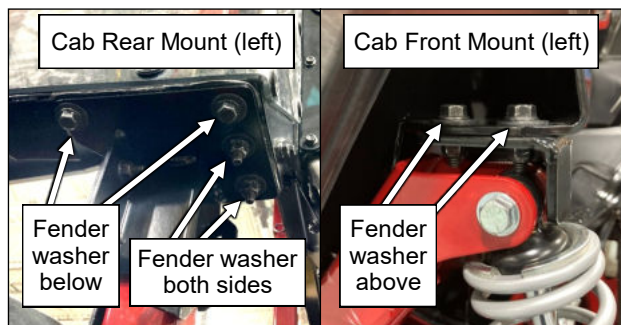

Fig. 4.8 (Cab mounting bolts)

CAB INSTALLATION

Step 5: (A/C Compressor Installation)

- 5.1 See fig. 5.1. Place the front flange of the A/C compressor bracket over the 1/2" ROPS bolt on the left side ROPS and loosely place a nut over the bolt. Secure the side flange of the compressor bracket to the rear vehicle flange with two 3/8" bolts installed from inside the frame. Torque the 1/2-13 ROPS bolts to 50 ft-lbs. (68 N-m).

Tools Required

3/4" hex wrenches or sockets

9/16" hex wrenches or sockets

Hardware Used

	Qty
1/2-13 Flanged Lock Nut	1
3/8-16x1.5" Flanged Hex Bolt	2
3/8-16 Flanged Lock Nut	2

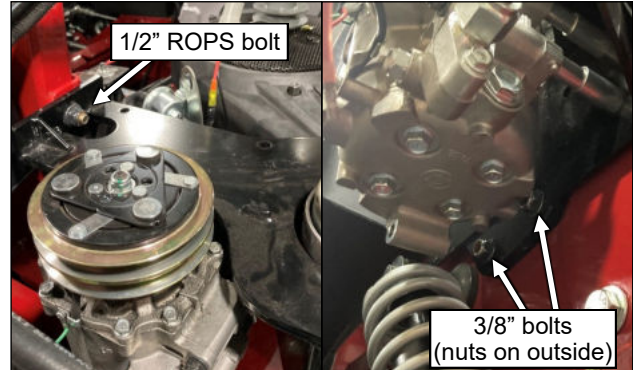

Fig. 5.1 (A/C compressor bracket)

Step 6: (A/C and Cab Wiring)

- 6.1 See fig. 6.1. Route the A/C harness toward the front of the cab between the ROPS and oil tank, below the flange at the bottom of the ROPS. Attach the wire harness to the tab on the right ROPS bracket with a 3/4" P-clamp, a 1/4-20 bolt, and a nut.

Tools Required

3/8" and 7/16" hex wrenches or sockets

Hardware Used

	Qty
3/4" P-clamp	1
1/4-20 x 3/4" Flanged Hex Bolt	1
1/4-20 Flanged Lock Nut	1



Fig. 6.1 (A/C wire harness)

- 6.2 Route the drain tube straight down towards the bottom of the mower, making sure the end of the tube is below the frame, and the tube is not near any moving parts.
- 6.3 Remove the console from the right side fuel tank with a 5/32" Allen wrench.

If the orange wire on the underside of the console (keyed power) is free, connect it to the yellow wire from the A/C harness, then route the A/C harness under the fuel tank and thru the opening for the console. See fig. 6.3. You may discard the short jumper harness provided. Re-attach the console to the fuel tank with a 5/32" Allen wrench.

If the orange wire on the underside of the console (keyed power) is in use, disconnect the orange wire from the light and connect it to the piggyback terminal on the short jumper wire provided. Attach the piggyback terminal to the light where the orange wire was removed. Route the A/C harness under the fuel tank and thru the opening for the console. Then plug the yellow signal wire from the A/C harness into the open end of the short jumper harness. See fig. 6.3a. Re-attach the console to the fuel tank with a 5/32" Allen wrench.

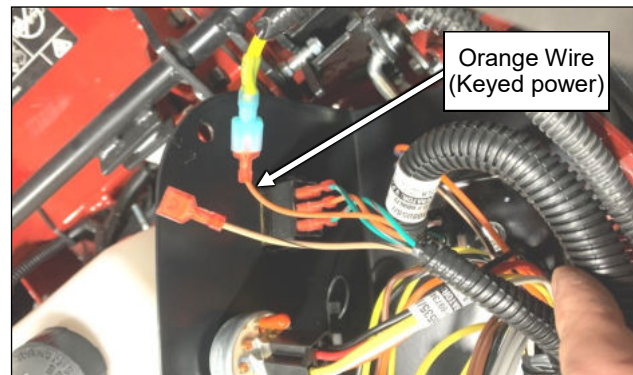

Fig. 6.3 (Keyed power connection, option 1 of 2)

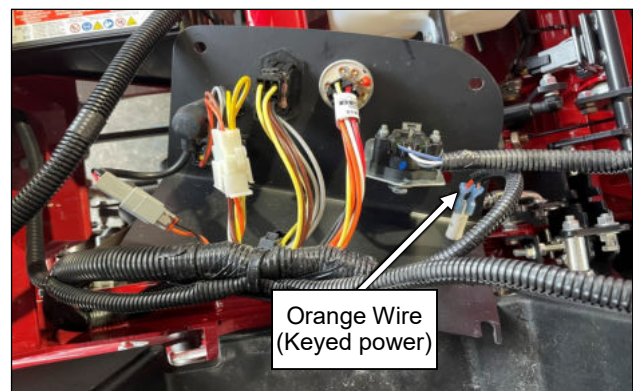

Fig. 6.3a (Keyed power connection, option 2 of 2)

CAB INSTALLATION

Step 5: (A/C Compressor Installation)

- 6.4 See fig. 6.4. Route the main trunk of the A/C harness to the left and behind the battery. Attach the ring terminals on the three red and orange wires to the bolt on the positive battery terminal. Place the rubber protective boot back over the positive terminal as neatly as possible.

Tools Required

7/16" wrench or socket

- 6.5 Connect the three black wires with ring terminals under the head of the bolt for the negative battery terminal, but do not re-connect the negative terminal at this time.
- 6.6 Route the A/C harness towards the rear of the mower, between the engine and compressor mount, then out through the bottom of the "F" on the side of the mower rear body.
- 6.7 See Fig. 6.7. Connect the bullet terminal from the harness to the compressor, and attach the ground lug to the bolt at the bottom-front of the compressor.

Tools Required

3/8" and 7/16" hex wrenches or sockets

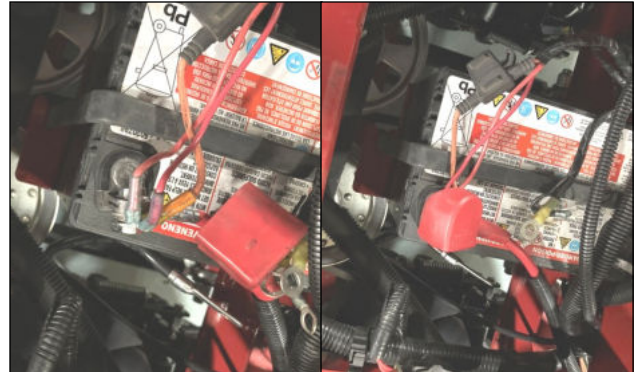

Fig. 6.4 (Positive wire connections)

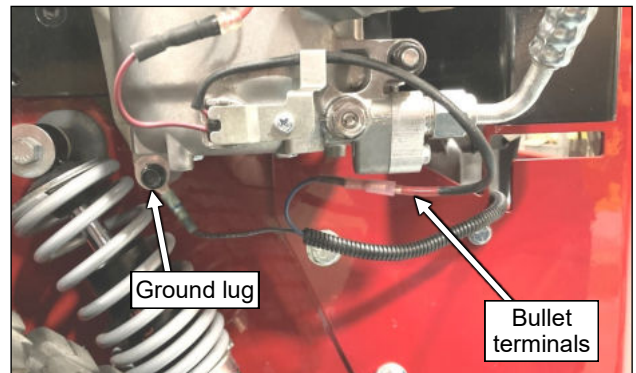

Fig. 6.7 (Compressor connections)

CAB INSTALLATION

Step 6: (A/C and Cab Wiring, continued)

- 6.8 See fig. 6.8. Connect the 2-pin connector from the voltage regulator attached to the rear frame of the cab, to the 2-pin connector from the main A/C wire harness. Connect the black wires with ring lugs under the nut on the left side of the regulator.

Tools Required

3/16" Allen key or driver
7/16" hex wrench or socket

- 6.9 See fig. 6.9. Connect the 4-pin connector from the regulator harness to the connector from the voltage regulator. Connect the other end of the harness to the dynamo mounted to the compressor bracket.

- 6.10 See fig. 6.10. Use wire ties to secure the A/C harness inside the cab, keeping wires away from any moving parts, especially the fan and belt.

Make sure the yellow wire with bullet terminal from the A/C harness, located near the battery, is accessible. This will be used for cab accessories.

- 6.11 See fig. 6.11. Secure the wires for the Voltage regulator together, and to the fuel hoses near the fuel cutoff switch. Orient the fuse holders so that the fuses will be accessible once the covers are put on the engine.
- 6.12 See fig. 6.12. Secure the compressor and dynamo wires to other wires next to the engine. Make sure the wires can't contact any hot or moving parts.
- 6.13 Carefully cut the excess tails from all wire ties.

Tools Required

Wire cutters or snips

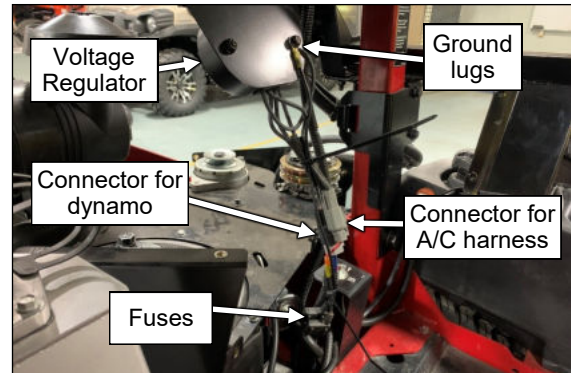

Fig. 6.8 (Voltage Regulator Connections)

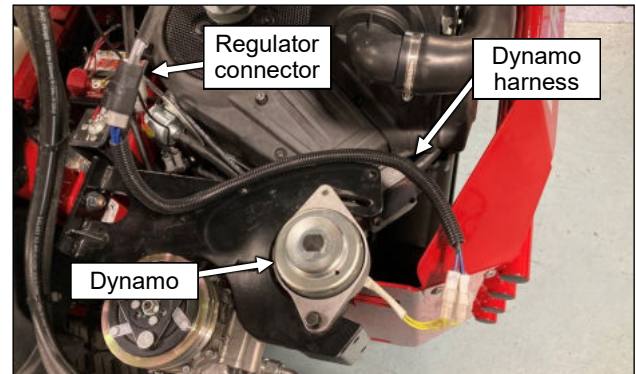

Fig. 6.9 (Dynamo connections)

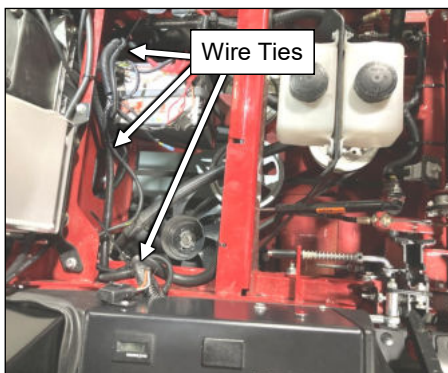

Fig. 6.10 (Secure wires under seat)

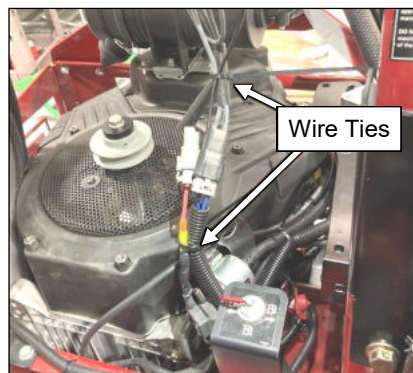

Fig. 6.11 (Secure regulator wires)

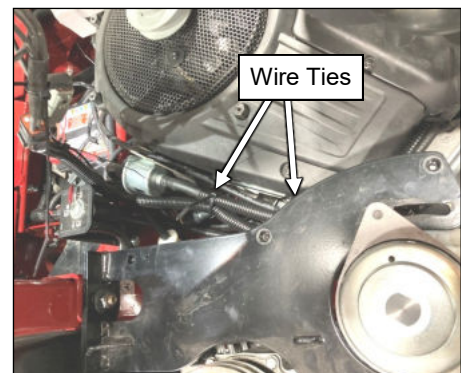

Fig. 6.12 (Secure compressor wires)

CAB INSTALLATION

Step 7: (A/C V-belt)

7.1 See fig. 7.1. Install the Flywheel Shroud Mount to the engine housing using 3 of the 4 M6 screws removed in step 1.3, and to the compressor mount with three 1/4" bolts and fender washers.

Tools Required

10mm hex wrench or socket
 3/8" and 7/16" hex wrenches or sockets

Hardware Used

Hardware Used	Qty
1/4-20 x 3/4" Flanged Hex Bolt	3
1/4" x 1" Steel Fender Washer	3

7.2 Loosen the left bolt on the dynamo attached to the A/C compressor bracket and rotate the dynamo counter clockwise to move the bolt forward in the slot.

Tools Required

13mm Wrench or Socket

7.3 See fig. 7.3. Place the V-belt from the hardware kit over the upper groove of the compressor pulley, over the dynamo pulley and over the new pulley on the engine crankshaft. Rotate the dynamo clockwise until the V-belt is tight, then tighten the left dynamo bolt snug.

7.4 Check the tightness of the V-belt by placing a straight edge tangent to compressor pulley and dynamo. Place belt tension tester in the center and perpendicular to the belt between the (2) pulleys and next to the straight edge. Push the tensioner towards the theoretical center making sure that a deflection force of 3.1 lbs. gets 0.2 inches of belt deflection at the center of the belt. See Figure 7.4.

Tools required

13mm wrench or socket
 Belt tension tester
 Straight edge

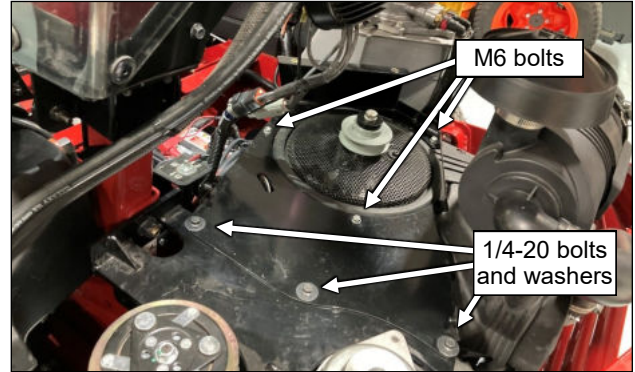

Fig. 7.1 (Flywheel shroud mount)



Fig. 7.3 (Install V-belt)

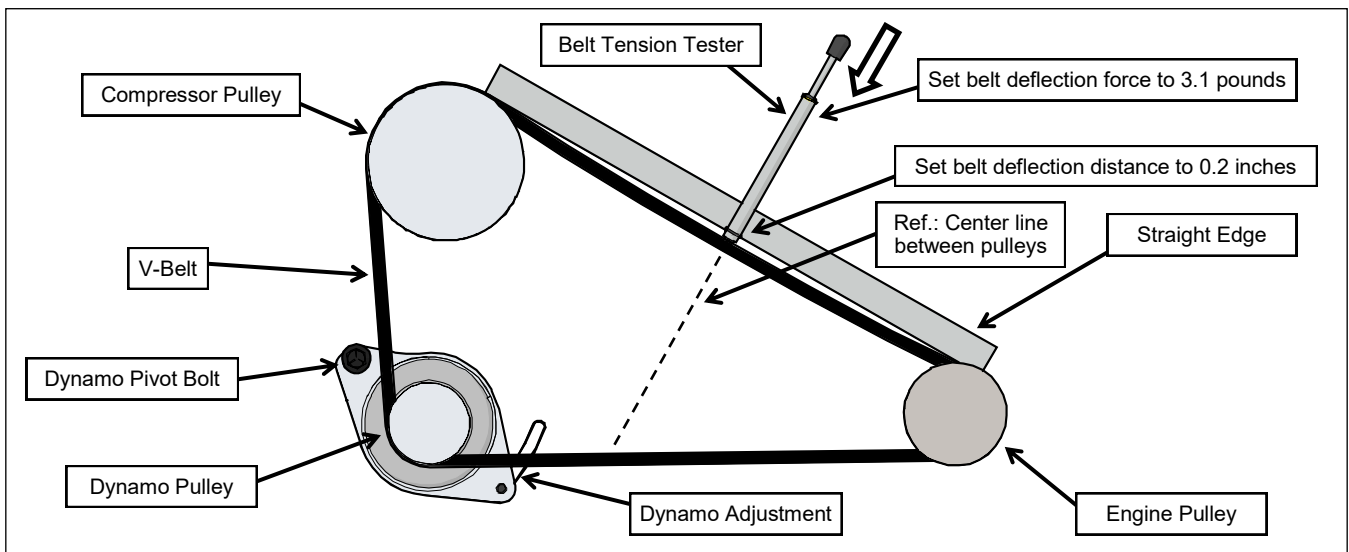

Fig. 7.4 (Compressor V-Belt Tension)

CAB INSTALLATION

Step 8: (Repositioning the Air Cleaner Assembly)

NOTE: This step is required for the 36HP engine, to create clearance for the flywheel shroud.
This step is not necessary for the 40HP engine.

- 8.1 See fig. 8.1. Remove the nut and double-ended bolt from the front tab of the air cleaner bracket.
Loosen the two bolts holding the rear tabs of the bracket and rotate the front of the bracket up.
Place the M8 x 35mm bolt through the bracket, slide the spacer onto the bolt under the bracket, then secure to the engine block. Tighten all three bolts.
Loosen the end cap on the air cleaner and rotate the valve toward the rear to clear the A/C shroud mount, then re-clamp the cap.

Tools Required

13mm hex wrench or socket

Hardware Used

M8 x 1.25 x 35mm Flanged Hex Bolt	<u>Qty</u> 1
.319" x 1/2"OD x 20mm Aluminum Spacer	1

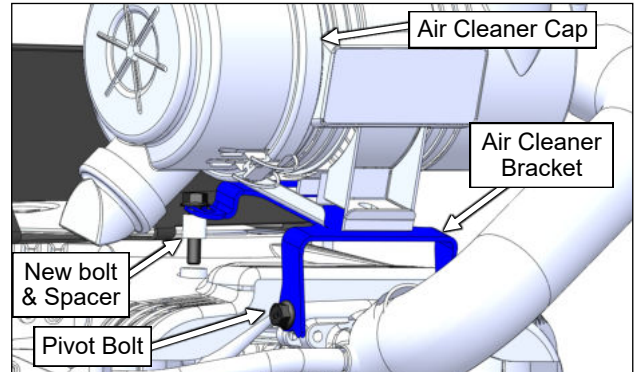

Fig. 8.1 (36HP Air Cleaner)

Step 9: (A/C Cover Panels)

- 9.1 See fig. 9.1. Install the Compressor Debris Cover onto the A/C compressor mount as shown.

Tools Required

3/8" hex wrench or socket

Hardware Used

1/4-20 x 5/8" Flanged Hex Bolt	<u>Qty</u> 4
--------------------------------	-----------------

- 9.2 Per fig. 9.2, secure the upper hose to the lower tab on the left ROPS mount with a 3/4" P-clamp, 1/4" x 1" bolt and nut. Secure each hose to the upper tab of the compressor debris cover with a P-clamp, bolt, and nut. Arrange the clamps and hoses so that the hoses will clear the cover then tighten snug.

Tools Required

3/8" and 7/16" hex wrenches or sockets

Hardware Used

3/4" P-clamp	<u>Qty</u> 3
1/4-20 x 3/4" Flanged Hex Bolt	2
1/4-20 Flanged Lock Nut	2

- 9.3 See fig. 9.3. Make sure all wires and hoses are secured, and nothing will contact any moving parts, then place the flywheel shroud on top of the A/C compressor assembly. Secure with 1/4" x 5/8" lg. screws and tighten snug,

Tools Required

3/8" hex wrench or socket

Hardware Used

1/4-20 x 5/8" Flanged Hex Bolt	<u>Qty</u> 12
--------------------------------	------------------

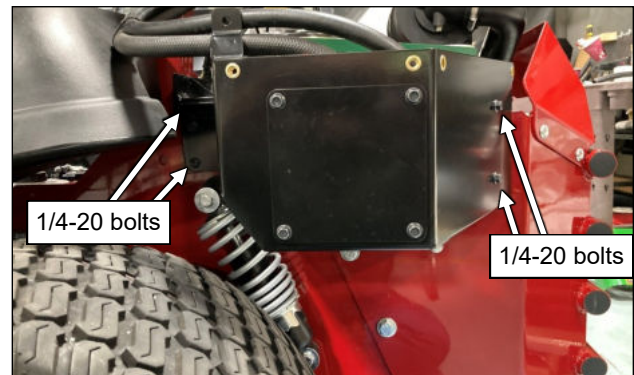

Fig. 9.1 (Compressor Debris Cover)

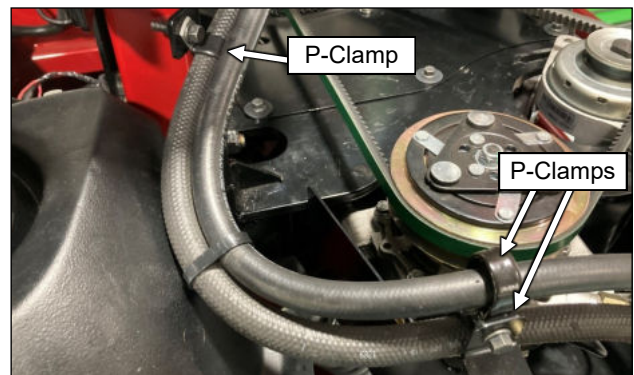

Fig. 9.2 (A/C hose P-clamps)

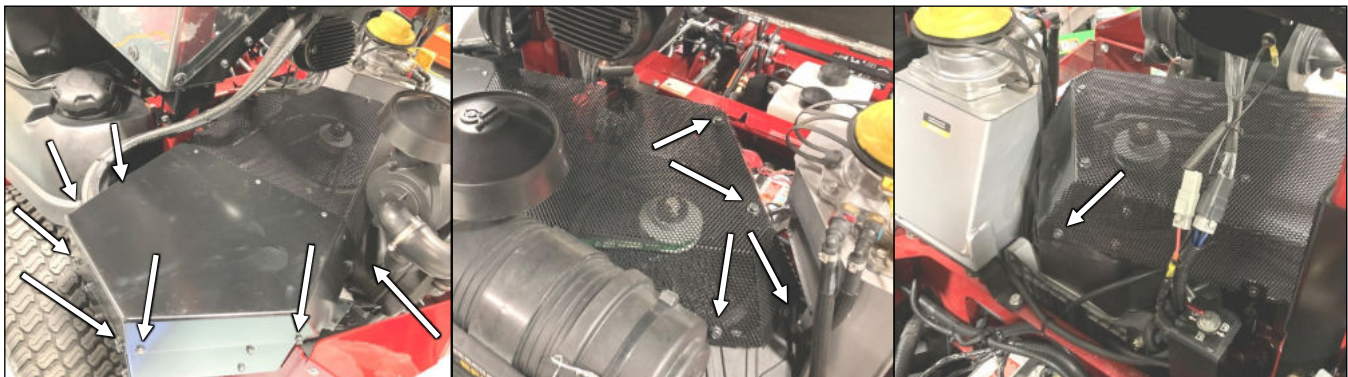

Fig. 9.3 (Flywheel shroud)

CAB INSTALLATION

Step 10: (Cab Filler Panels)

- 10.1 See fig. 10.1. Place the longer strip of self-adhesive arch foam (7" long) onto edge of the bend on the left side of the deck height adjustment pin box.

<u>Hardware Used</u>	<u>Qty</u>
Arch P.S.A. rubber, 3/4" wide	7"

- 10.2 Remove and discard the carriage bolt from the right side front floorboard.
- 10.3 Per fig. 10.3, install the deck height control cover over the pin box and deck height lever, and secure to the cab with 1/4" x 5/8" lg. bolts and nuts. Tighten snug.

Tools Required

3/8" and 7/16" hex wrenches or sockets

<u>Hardware Used</u>	<u>Qty</u>
1/4-20 x 5/8" Flanged Hex Bolt	5
1/4-20 Flanged Lock Nut	5

- 10.4 Secure the inner flange of the deck control cover to the front floorboard with a button head bolt, flanged washer, and a nut underneath. Tighten snug.

Tools Required

3/16" Allen key or driver

1/2" hex wrench or socket

<u>Hardware Used</u>	<u>Qty</u>
5/16-18 x 1" Button Head Bolt	1
5/16" x 1" Steel Fender Washer	1
5/16-18 Flanged Lock Nut	1

- 10.5 Per figure 10.5, place the shorter strip of self-adhesive arch foam (5.5") onto the back edge of the deck control cover, to seal to the right fender / fuel tank. Leave no visible gap at the right corner and along the front of the tank.

<u>Hardware Used</u>	<u>Qty</u>
Arch P.S.A. rubber, 3/4" wide	5-1/2"

- 10.6 See fig. 10.6. Remove and discard the carriage bolt from the left side of the front floorboard, place the left floorboard filler panel into the corner of the front floorboard, and secure with a button head bolt, fender washer, and nut. Adjust the panel to remove any visible gaps as much as possible then tighten snug.

Tools Required

3/16" Allen key or driver

1/2" hex wrench or socket

<u>Hardware Used</u>	<u>Qty</u>
5/16-18 x 1" Button Head Bolt	1
5/16" x 1" Steel Fender Washer	1
5/16-18 Flanged Lock Nut	1

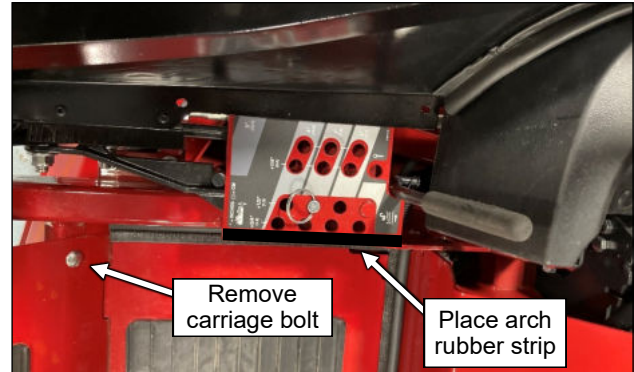

Fig. 10.1 (Deck control foam seal)

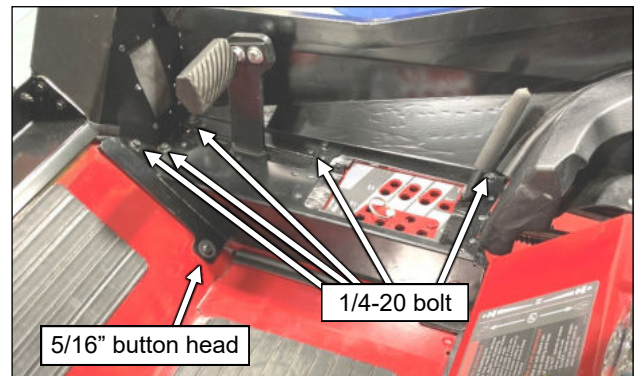

Fig. 10.3 (Deck Control Cover)

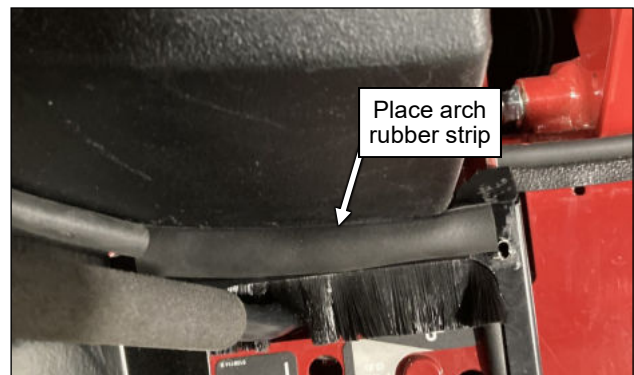

Fig. 10.5 (Rear deck control seal)



Fig. 10.6 (Left floorboard filler panel)

CAB INSTALLATION

Step 10: (Cab Filler Panels, continued)

10.7 Rotate the seat forward. Per fig. 9.7, remove the rear bolt from the right control arm mechanism. Place the right inner filler bracket on the outside of the vehicle's frame flange, then secure with a 5/16" bolt through the control arm mechanism, frame flange and into the rivet nut of the bracket. Leave slightly loose.

Tools Required

1/2" hex wrenches or sockets

Hardware Used

5/16-18 x 1" Flanged Hex Bolt

Qty
1

10.8 See Fig. 10.8. Remove both bolts from the left side control arm mechanism. Place 5/16 x 1-1/4" lg. bolts through the frame flange and control arm mechanism from the outside of the flange. Place a spacer on each bolt, then the left inner panel bracket on the inside of the frame flange and secure with nuts. Tighten to 11 ft-lbs. (15 N-m)

Tools Required

1/2" hex wrenches or sockets
(open-end wrench to tighten)

Hardware Used

5/16-18 x 1-1/4" Flanged Hex Bolt 2
.459" x 5/8" x 1/4" Steel Spacer 2
5/16-18 Flanged Lock Nut 2

Qty
2
2
2

10.9 See Fig. 9.9. Loosen the top of the Velcro on the vinyl boot of the right under-seat panel and slide the boot over the right control lever. Slide the parking brake lever through the slit in the rubber seal of the under-seat panel. Work the panel down into place against the fuel tank, around the wire harness attached to the right side mower console. Secure the panel to the bracket from step 8.7 with two 1/4" flanged button head bolts. Secure the front tab of the panel to the deck control cover with a sheet metal screw. Tighten the button head bolts snug. Tighten the 5/16" bolt for the bracket to 11 ft-lbs. (15 N-m). Close the Velcro of the control lever boot around the lever.

Tools Required

5/32" Allen key or driver
Hand drill with #2 Phillips driver

Hardware Used

1/4-20 x 5/8" Flanged Button Head Bolt 2
#8 x 1/2" Sheet Metal Screw 1

Qty
2
1

10.10 See fig. 10.10. Loosen the Velcro at the top of the control lever boot on the left under-seat panel. Slide the boot over the left control lever and into place against the left fuel tank. Secure with two 1/4" flanged button head bolts and tighten snug. Close the Velcro around the control arm.

Tools Required

5/32" Allen key or driver

Hardware Used

1/4-20 x 5/8" Flanged Button Head Bolt 2

Qty
2

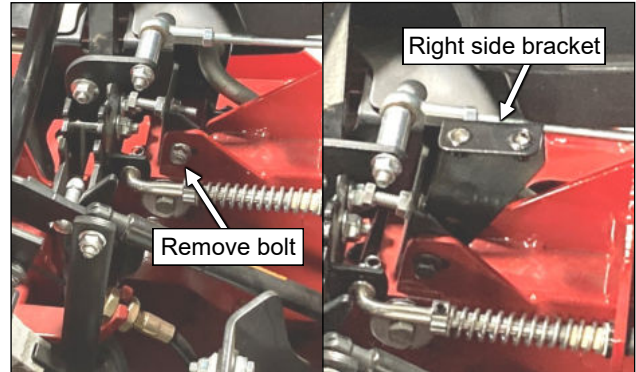

Fig. 10.7 (Right side inner panel bracket)

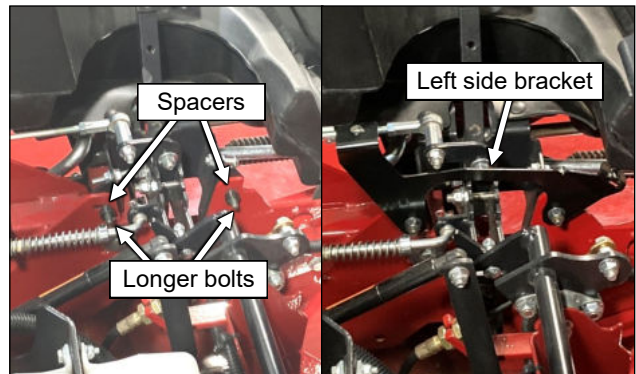

Fig. 10.8 (Left side inner panel bracket)

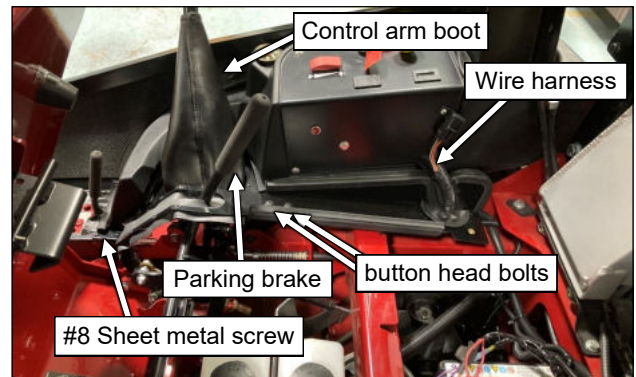

Fig. 10.9 (Right side under-seat panel)

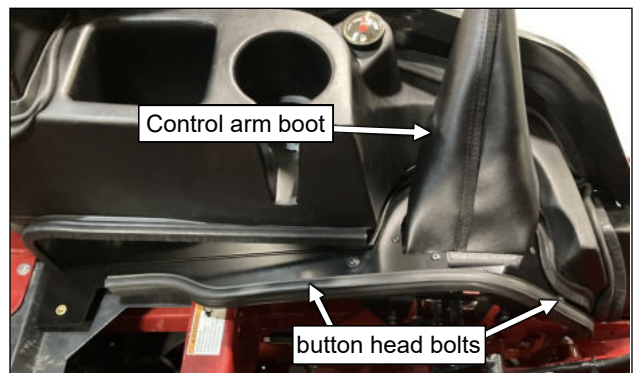

Fig. 10.10 (Left side under-seat panel)

CAB INSTALLATION

Step 10: (Cab Filler Panels, continued)

10.11 See fig. 10.11. Attach the headrest mount assembly (from step 2.4) to the rear frame with thumb screws and fender washers. Adjust the height of the headrest as desired, then tighten the thumb screws finger tight.

<u>Hardware Used</u>	<u>Qty</u>
1/4-20 x 3/4" Thumb Screw	4
1/4" x 1" Steel Fender Washer	4

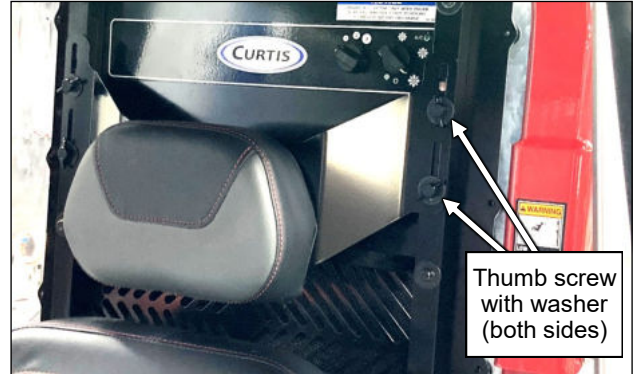

Fig. 10.11 (Headrest mount)

Step 11: (Final steps)

11.1 Re-connect the negative terminal to the battery.

Tools Required

10mm hex wrench or socket

11.2 Lower the seat down. Turn on vehicle and test operation of the A/C Unit. If the A/C Unit does not function properly, check out the "Troubleshooting" section of this manual. See fig. 10.2 for basic A/C operation.

11.3 Install any accessories purchased for this vehicle.

11.4 See Fig. 11.4. Raise the seat forward. Place the lower rear panel inside the cab against the cab panels. Secure the rear panel to the bottom of each under-seat panel with a 1/4" bolt and fender washer. Secure the rear panel to each side frame panel with two 1/4" bolts and fender washers. Secure the top of the rear panel to the rear frame with two 1/4" bolts (no washers here). Tighten all bolts snug.

Tools Required

3/8" hex wrench or socket

Hardware Used

<u>Hardware Used</u>	<u>Qty</u>
1/4-20 x 5/8" Flanged Hex Bolt	8
1/4" x 1" Steel Fender Washer	6

11.5 See fig. 11.5. Re-install doors and install gas shocks. The end with the red tab should be attached to the side frame of the vehicle.

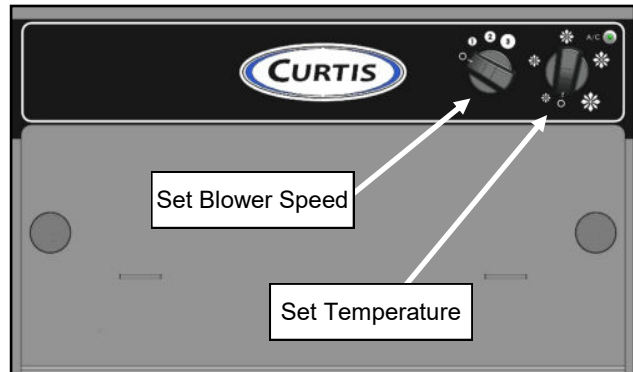

Fig. 11.2 (Test A/C Unit Functionality)

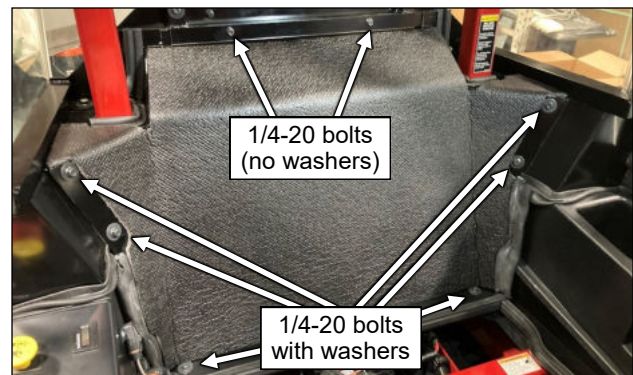

Fig. 11.4 (Lower Rear Panel)

The cab installation is now complete.

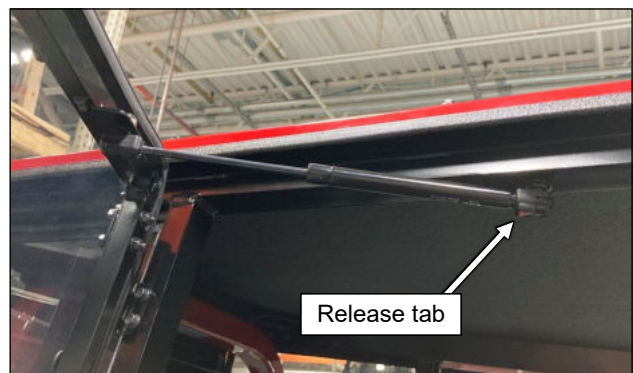

Fig. 11.5 (Door gas shocks, right shown)

CAB FEATURES & OPERATION

AIR CONDITIONING OPERATION

Turn the 4-position ventilation switch to activate the blower. This can be used as just a blower with the A/C compressor turned off.

Rotate the A/C switch to the desired temperature setting to turn the compressor on/off.

In order for the A/C compressor to function, the vehicle throttle must be set at full speed.

The blower must be turned on in order for the A/C compressor to function.

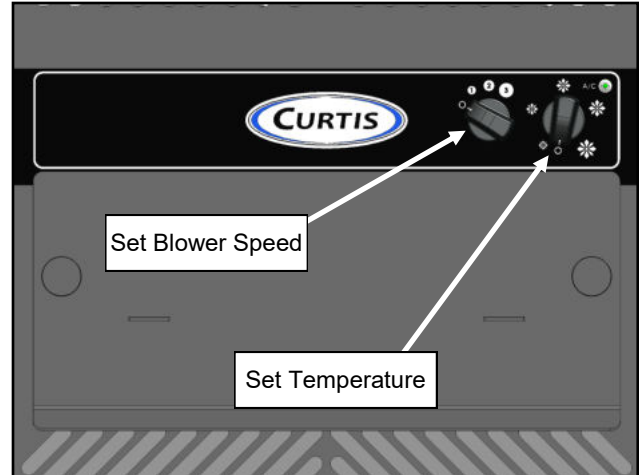

A/C Controls

AIR FILTER CHECK

Remove the four thumbscrews and washers then remove the headrest mount from the rear frame.

Remove the two thumbscrews on the face of the A/C and slide the drawer out to access the air filter.

Change the filter as needed based on operating conditions.

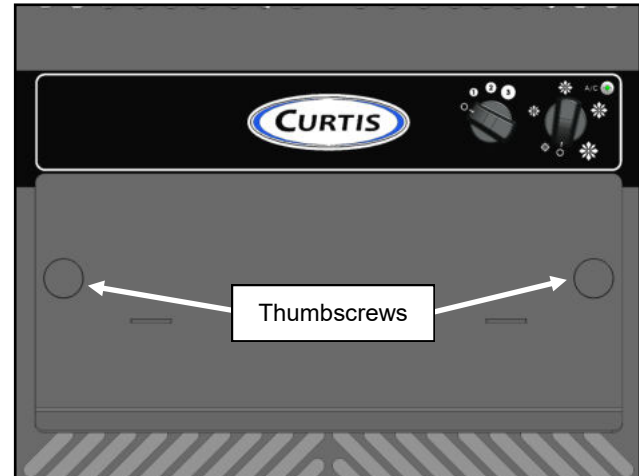

Air Filter Access

CARE AND MAINTENANCE

- DO NOT use glass cleaner to clean windows. It will damage the material. Mild dish soap and water should be used to clean all window panels. Use a soft bristled brush or sponge to clean panels.
- Avoid wiping the windows while they are dry. Hose down with water to remove heavy debris before wiping windows. Water acts as a lubricant to help prevent scratches.
- Re-apply grease periodically as needed to the door striker pins, door latch assemblies, and the door hinges.
- Check the belt tension after the first 10 hours of use.
- Check and tighten hardware after 40 hours of operation. Periodically inspect and tighten hardware for the remainder of the unit's life. Check for any wearing or chaffing on hoses or wiring and correct as necessary.
- Wash the painted surfaces of the cab with commercial automotive cleaning products.
- Change cabin air filter as required depending on usage conditions.
- Inspect / clean the exterior of the condenser of all dust and debris daily.
- This product is designed with the use of R134a as a refrigerant. Never substitute other refrigerants, use of any other refrigerant will void warranty.
- Charge unit with 2.3 lbs. of R134a refrigerant.
- Apply vacuum for a minimum of 30 minutes prior to charging the air conditioner with R134a.
- Do not vent refrigerant to the atmosphere. If the unit has to be discharged for any reason, recover the refrigerant in compliance with federal, state, and local laws.
- Refrigerant Oil - use only ZEROL ESTER 68SL to replenish any oil lost during refrigerant recovery.
- Replace the drier receiver (9SV-9AC-00003) when replacing a compressor (9SV-9AC-00006).

TROUBLESHOOTING

- Ensure that throttle lever is activating the switch when moved to its max rpm position. An audible click should be heard when moving the throttle with the vehicle off.
- Check all electrical connections to ensure that proper connections are made and terminals are all tight.
- Check Battery Condition:
Resting/No Load Voltage should be 12.35V or greater.
Terminals should be clean and tight.
- Check all fuses:
30 amp fuse located at battery.
15 amp fuse located near relays, located inside the air conditioner (accessible with filter drawer removed).
20 amp fuse located near regulator under operator's seat.
- Check both relays. Located inside the air conditioner (accessible with filter drawer removed).
- Check regulator output. The output should be 12-14 volts DC.
- Check the tension of the OEM and secondary drive belts.

SERVICE PARTS

ROOF ASSEMBLY
P/N: 8SV-101-00066

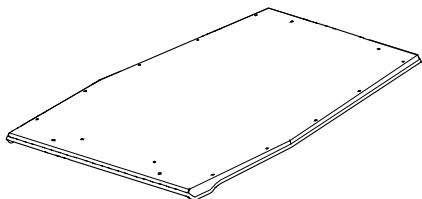

WINDSHIELD ASSEMBLY
P/N: 8SV-102-00040

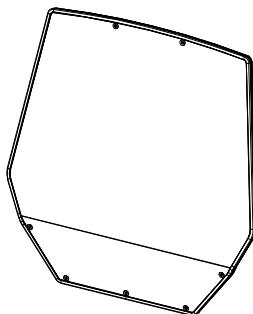

WINDSHIELD SUPPORT ASSEMBLY
P/N: 8SV-103-00030

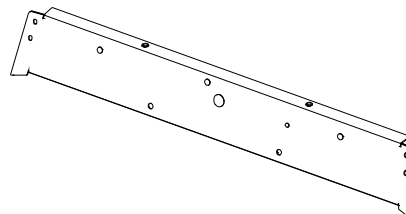

REAR PANEL ASSEMBLY
P/N: 8SV-106-00045

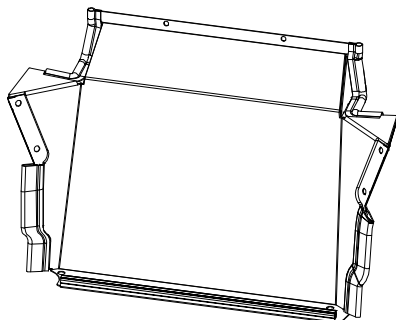

DOOR ASSEMBLY, LEFT
P/N: 8SV-107-00058-L

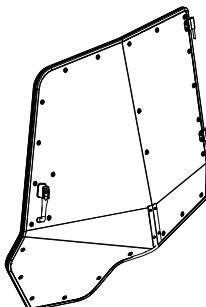

DOOR ASSEMBLY, RIGHT
P/N: 8SV-107-00058-R

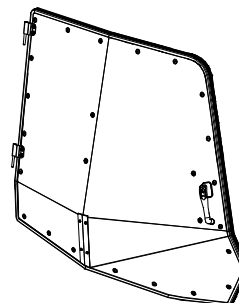

SIDEFAME ASSEMBLY, LEFT
P/N: 8SV-109-00027-L

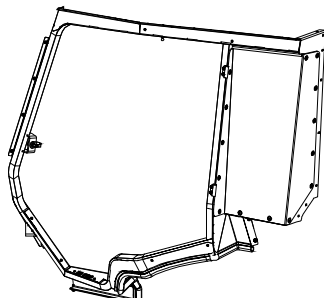

SIDEFAME ASSEMBLY, RIGHT
P/N: 8SV-109-00027-R

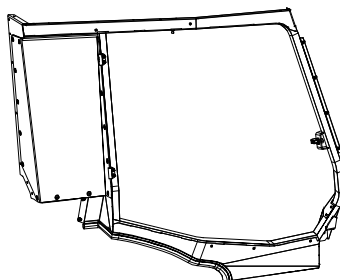

FRONT FLOORBOARD ASSEMBLY
P/N: 8SV-105-00035

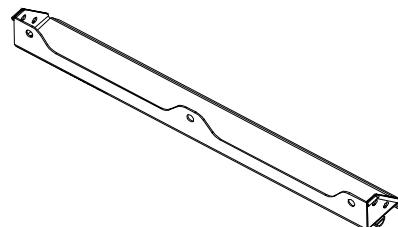

REAR BRACE ASSEMBLY
P/N: 8SV-113-00298

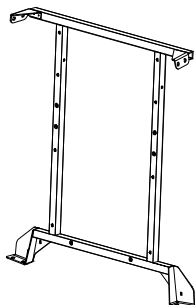

A-PILLAR CLAMP, LEFT
P/N: 8SV-SM-02374-L



A-PILLAR CLAMP, RIGHT
P/N: 8SV-SM-02374-R



SERVICE PARTS

UPPER REAR PANEL
P/N: 8SV-111-00043

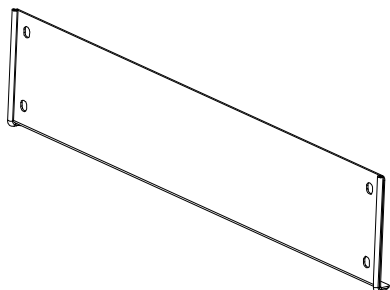

A/C UNIT, REAR MOUNTED
P/N: 8SV-302-00008-BP

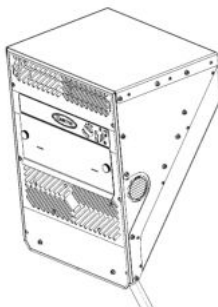

A/C COVER ASSEMBLY
P/N: 8SV-303-00013-BP

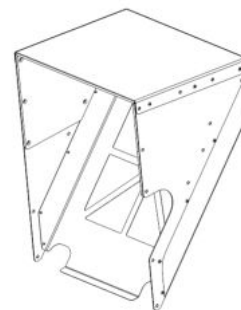

ROPS MOUNT, LEFT
P/N: 8SV-110-00110-L

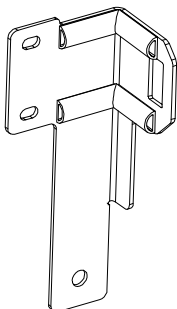

ROPS MOUNT, RIGHT
P/N: 8SV-111-00110-R

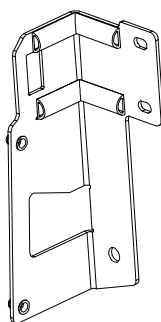

ROPS CLAMP, LEFT
P/N: 8SV-110-00111-L

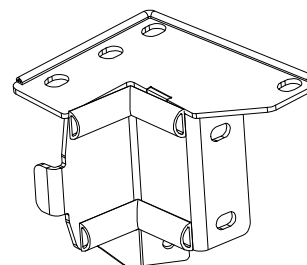

ROPS CLAMP, RIGHT
P/N: 8SV-110-00111-R

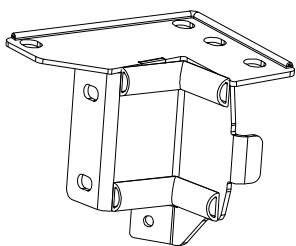

A/C AIR DIVERTER FLAP
P/N: 8SV-113-00258-BP

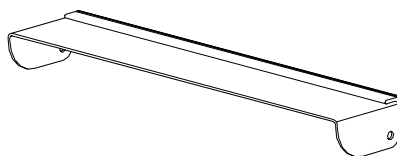

V-BELT
P/N: 9SV-9BLT-15

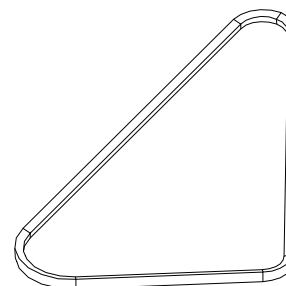

DYNAMO
P/N: 9SV-9ALT-06

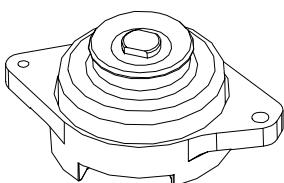

FLYWHEEL STUB SHAFT
P/N: 9SV-MP-00085

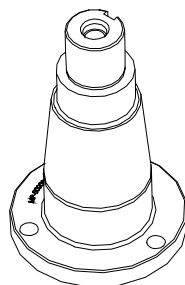

REGULATOR/RECTIFIER
P/N: 8SV-114-00041

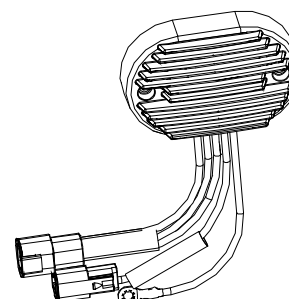

SERVICE PARTS

FRONT MOUNT BRACKET, LEFT
P/N: 8SV-SM-02296-L

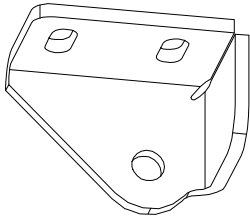

FRONT MOUNT BRACKET, RIGHT
P/N: 8SV-SM-02296-R

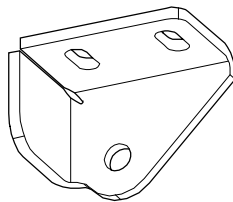

COMPRESSOR BRACKET
P/N: 8SV-WA-00567

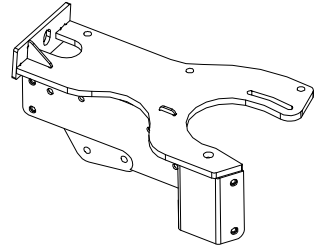

FLYWHEEL SHROUD MOUNT
P/N: 8SV-113-00312

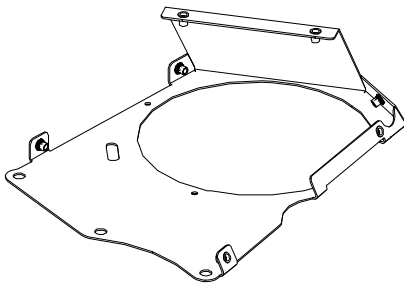

COMPRESSOR DEBRIS COVER
P/N: 8SV-113-00300

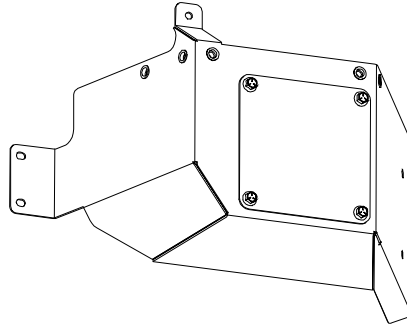

FLYWHEEL SHROUD
P/N: 8SV-113-00342

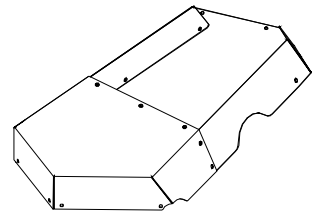

REGULATOR MOUNT BRACKET
P/N: 8SV-SM-02530

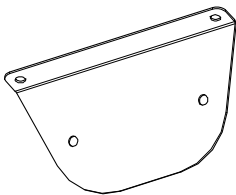

ACCESS COVER, RECHARGE PORT
P/N: 8SV-SM-02449

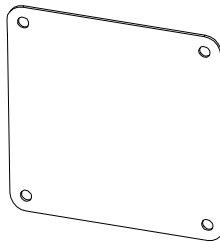

CRANKSHAFT PULLEY
P/N: 9SV-MP-00083-ZY

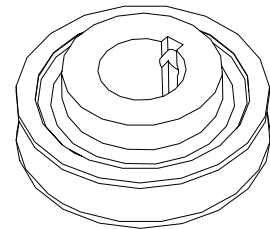

A/C COMPRESSOR
P/N: 8SV-9AC-00051

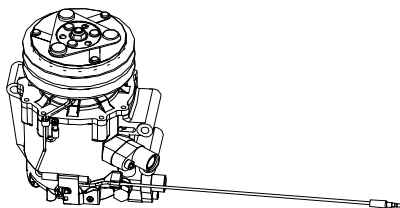

HOSE, #8, COMP TO COND
P/N: 8SV-305-00027

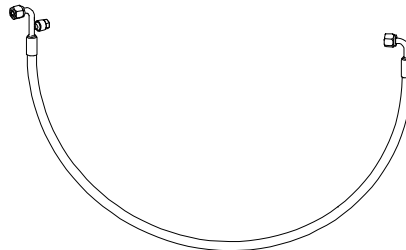

HOSE, #6, DRIER TO EVAP
P/N: 8SV-305-00023

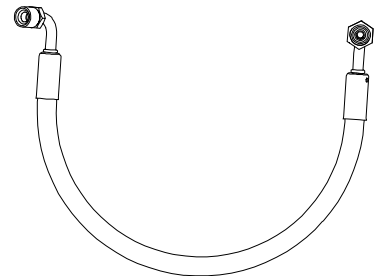

SERVICE PARTS

HOSE, #10 EVAP TO COMP
P/N: 8SV-305-00026

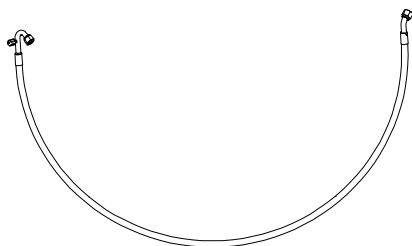

HOSE, #6, COND TO DRYER
P/N: 8SV-305-00025

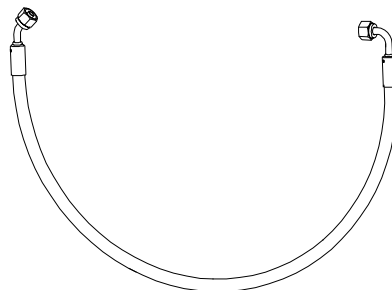

REAR LEG WINDOW, LEFT W/
HARDWARE
P/N: 8SV-P-00161-L

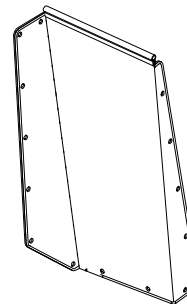

DOOR SKIN, LEFT, W/ HARDWARE
P/N: 8SV-P-00163-L

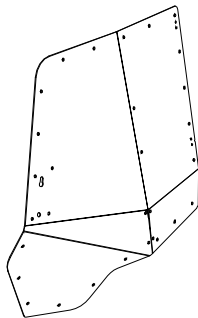

DOOR SKIN, RIGHT, W/ HARDWARE
P/N: 8SV-P-00163-R

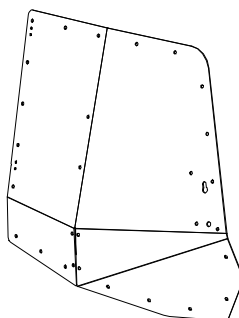

REAR LEG WINDOW, RIGHT W/
HARDWARE
P/N: 8SV-P-00161-R

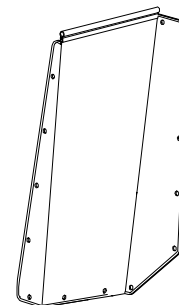

KNOB
P/N: 9SV-OHC-27

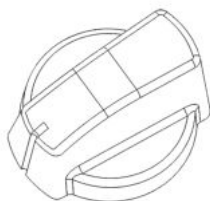

LOUVERED PLUG WITH FILTER
P/N: 9SV-9DP25

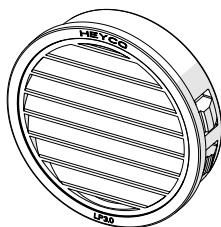

EVAPORATOR
P/N: 8SV-9AC-00046

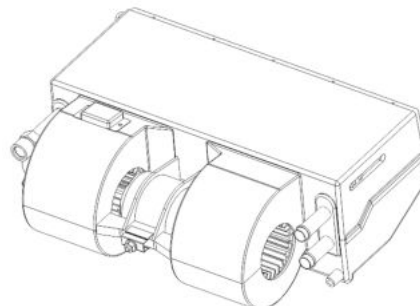

A/C WIRE HARNESS
P/N: 9SV-WH-00148



WIRE HARNESS, A/C DYNAMO
P/N: 9SV-WH-00149



HEADREST MOUNT
P/N: 8SV-SM-02378

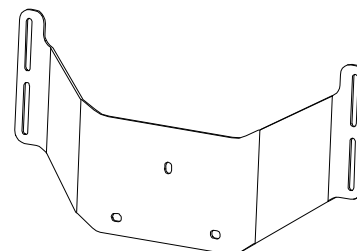

SERVICE PARTS

DECK CONTROL COVER
P/N: 8SV-111-00042

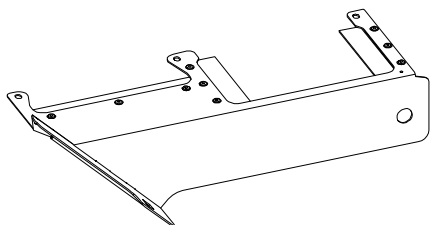

INNER FILLER BRACKET, LEFT
P/N: 8SV-110-00119-L

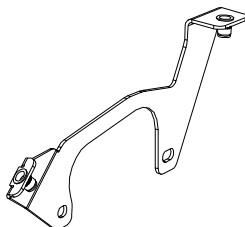

INNER FILLER BRACKET, RIGHT
P/N: 8SV-110-00119-R

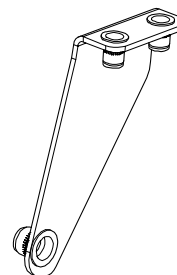

SEAT LEVER SEAL PANEL
P/N: 8SV-111-00049

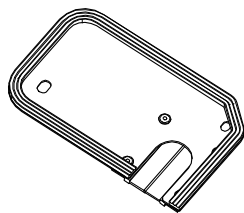

UNDER SEAT FILLER ASSEMBLY, LEFT
P/N: 8SV-111-00047-L

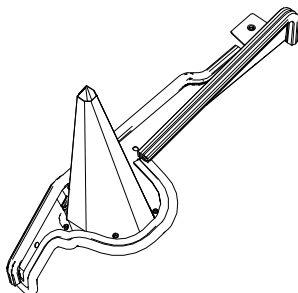

UNDER SEAT FILLER ASSEMBLY, RIGHT
P/N: 8SV-111-00047-R

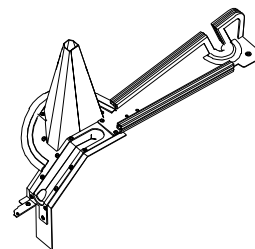

LEFT FLOORBOARD FILL PANEL
P/N: 8SV-SM-02564

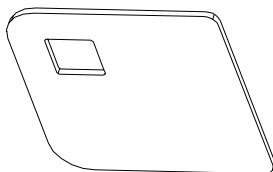

DRIVE HANDLE FILLER, LEFT
W/ HARDWARE
P/N: 8SV-112-00083-L

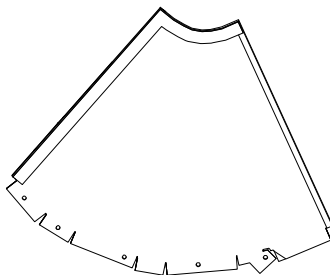

DRIVE HANDLE FILLER, RIGHT
W/ HARDWARE
P/N: 8SV-112-00083-R

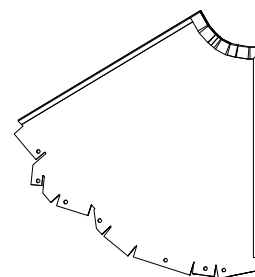

PULLEY RETAINING WASHER
P/N: 8SV-SM-02373

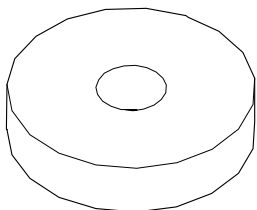

AIR FILTER
P/N: 9SV-9HR-00032

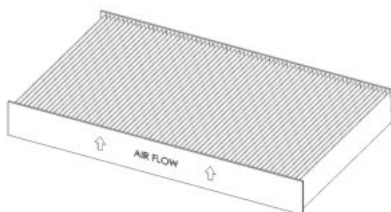

FLOOR MAT, VEHICLE FOOTREST
P/N: 8SV-9FR-00128

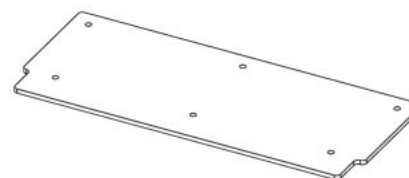

SERVICE PARTS

FLOOR MAT, VEHICLE FLOORBOARD
P/N: 8SV-9FR-00125

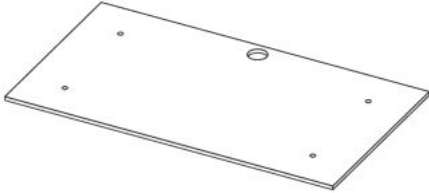

VEHICLE FOOTREST WITH FLOOR MAT
P/N: 8SV-113-00450

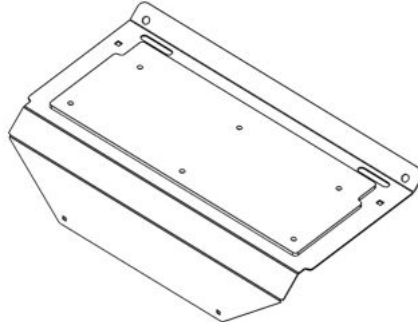

WIRE HARNESS, POWER JUMPER
P/N: 9SV-WH-00035

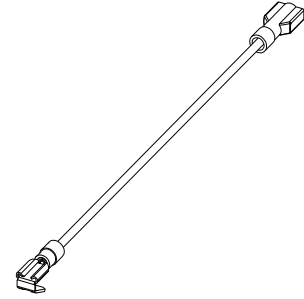

CONDENSER, PLENUM, & FAN
P/N: 8SV-304-00027-BP

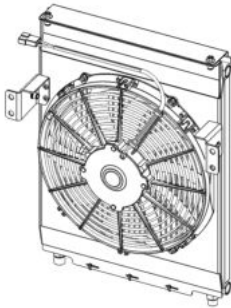

ADDITIONAL SERVICE PARTS

PART NUMBER	DESCRIPTION
9SV-HWK-00187	HARDWARE KIT, PREP AND CAB INSTALL
9SV-HWK-00188	HARDWARE KIT, COVER PANELS
9SV-OHRL-G	OUTSIDE DOOR HANDLE (SET OF 2)
9SV-GH	INTERIOR GRAB HANDLE (SET OF 2)
9SV-HSLP	HINGE PINS AND SLEEVES (2L + 2R)
9SV-DP10	DOME PLUG, .375" HOLE (BAG OF 10)
9SV-DP16	DOME PLUG, .750" HOLE (BAG OF 4)
9SV-DP04	DOME PLUG, 1.125" HOLE (BAG OF 15)
9SV-9OR-01	O-RINGS, (INCL 1 OF EA: .301" ID .426" ID .551" ID)
9SV-GS02A	BALL STUD 10MM (BAG OF 10)
9SV-DL06S	INTERIOR DOOR LATCH W/COVER (1L +1R)
9SV-9AC-00001	CONDENSER
9SV-85-01-0076	RELAY, 12VDC, 50/30A, SPDT, MINI ISO
9SV-9AC-00003	DRIER RECEIVER
9SV-9AC-00005	PRESSURE SWITCH, 2-28KG/CM2
9SV-9AC-00007	AXIAL FAN FOR CONDENSER
9SV-DSTRH	DOOR STRIKER PIN (BAG OF 5)
9SV-GS02Q	GAS SHOCK 12-3/8" (SET OF 2)
9DL01H	KEYS, SET OF 2 ON A RING, FOR HANDLE 1096-1, KEY CODE C40
9SV-9AC-00046-BS	BLOWER SWITCH
9SV-9AC-00046-TS	THERMOSTAT SWITCH

TRIM LOK, STD,
1/16" - 1/8" GRIP



9SV-PRO1-20

5/8" STD BULB,
1/16" GRIP



9SV-PRO2-15

1" FLAT BULB
1/16" GRIP



9SV-PRO5-10

5/8" STD BULB
3/16" GRIP



9SV-PRO7-5

ARCH RUBBER
P.S.A.



9SV-PRO9-10

3/4" SIDE BULB,
1/16" GRIP



9SV-PR17-20

1" ROUND BULB,
1/16" GRIP

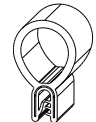

9SV-PR19-10

1/2"
WEATHERSEAL



9SV-PR20-10

FOAM TAPE,
1/8" X 2"



9SV-PR35-5

3/4" SIDE BULB,
1/4" GRIP



9SV-PR38-15

ARCH PSA,
.20" X .15"

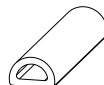

9SV-PR53-15



BOLT TORQUE

BOLT TORQUE SPECIFICATIONS

GENERAL TORQUE SPECIFICATION TABLE

Use the following torques when special torques are not given. These values apply to fasteners as received from suppliers, dry, or when lubricated with normal engine oil. They do not apply if special graphited or moly disulphide greases or other extreme pressure lubricants are used. This applies to both UNF and UNC threads. Remember to always use grade five or better when replacing bolts.

IMPORTANT: On all PLATED GRADE 8 bolts, reduce torque 15% from listed bolt torque specification.

SAE Grade No.		2				5				8*			
Bolt head identification mark as per grade. NOTE: Manufacturing Marks Will Vary													
		TORQUE		TORQUE		TORQUE		TORQUE		TORQUE		TORQUE	
Bolt Size		Pounds Feet		Newton-Meters		Pounds Feet		Newton-Meters		Pounds Feet		Newton-Meters	
Inches	Millimeters	Min.	Max.	Min.	Max.	Min.	Max.	Min.	Max.	Min.	Max.	Min.	Max.
1/4	6.35	5	6	7	8	9	11	12	15	12	15	16	20
5/16	7.94	10	12	14	16	17	20.5	23	28	24	29	33	39
3/8	9.53	20	23	27	31	35	42	48	57	45	54	61	73
7/16	11.11	30	35	41	47	54	64	73	87	70	84	95	114
1/2	12.70	45	52	61	70	80	96	109	130	110	132	149	179
9/16	14.29	65	75	88	102	110	132	149	179	160	192	217	260
5/8	15.88	95	105	129	142	150	180	203	244	220	264	298	358
3/4	19.05	150	185	203	251	270	324	366	439	380	456	515	618
7/8	22.23	160	200	217	271	400	480	542	651	600	720	814	976
1	25.40	250	300	339	406	580	696	787	944	900	1080	1220	1464
1-1/8	25.58	-	-	-	-	800	880	1085	1193	1280	1440	1736	1953
1-1/4	31.75	-	-	-	-	1120	1240	1519	1681	1820	2000	2468	2712
1-3/8	34.93	-	-	-	-	1460	1680	1980	2278	2380	2720	3227	3688
1-1/2	38.10	-	-	-	-	1940	2200	2631	2983	3160	3560	4285	4827

*Thick Nuts must be used with Grade 8 bolts

METRIC BOLT TORQUE SPECIFICATIONS



Size of Screw	Property Class	Course Thread			Fine Thread		
		Pitch (mm)	Pounds Feet	Newton-Meters	Pitch (mm)	Pounds Feet	Newton-Meters
M6	5.6	1.0	3.6-5.8	4.9-7.9	-	-	-
	8.8		5.8-9.4	7.9-12.7		-	-
	10.9		7.2-10	9.8-13.6		-	-
M8	5.6	1.25	7.2-14	9.8-19	1.0	12-17	16.3-23
	8.8		17-22	23-29.8		19-27	25.7-36.6
	10.9		20-26	27.1-35.2		22-31	29.8-42
M10	5.6	1.5	20-25	27.1-33.9	1.25	20-29	27.1-39.3
	8.8		34-40	46.1-54.2		35-47	47.4-63.7
	10.9		38-46	51.5-62.3		40-52	54.2-70.5
M12	5.6	1.75	28-34	37.9-46.1	1.25	31-41	42-55.6
	8.8		51-59	69.1-79.9		55-68	75.9-92.1
	10.9		57-66	77.2-89.4		62-75	84-101.6
M14	5.6	2.0	49-56	66.4-75.9	1.5	52-64	70.5-86.7
	8.8		81-93	109.8-126		90-106	122-143.6
	10.9		96-109	130.1-147.7		107-124	145-168
M16	5.6	2.0	67-77	90.8-104.3	1.5	69-83	93.6-112.5
	8.8		116-130	157.2-176.2		120-138	162.6-187
	10.9		129-145	174.8-196.5		140-158	189.7-214.1
M18	5.6	2.0	88-100	119.2-136	1.5	100-117	136-158.5
	8.8		150-168	203.3-227.6		177-199	239.8-269.6
	10.9		175-194	237.1-262.9		202-231	273.7-313
M20	5.6	2.5	108-130	146.3-176.2	1.5	132-150	178.9-203.3
	8.8		186-205	252-277.8		206-242	279.1-327.9
	10.9		213-249	288.6-337.4		246-289	333.3-391.6